

RAYTOOLS

EMC

1)

2)

1)

2)

3)

4)

5)

1)

2)

3)

1.

1.1

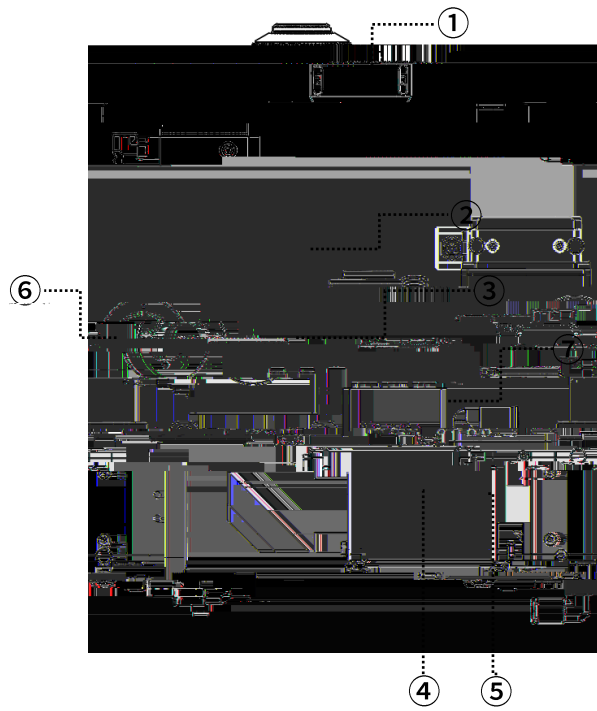
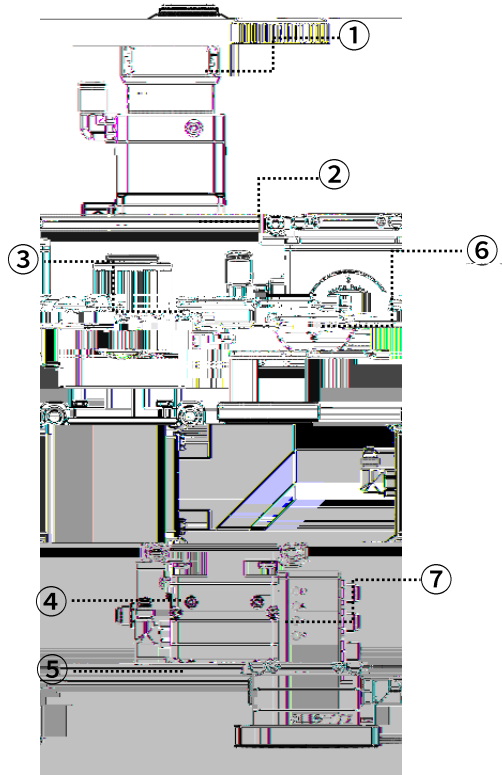

①	
②	
③	
④	
⑤	
⑥	
⑦	

1.2



F100/ 0°

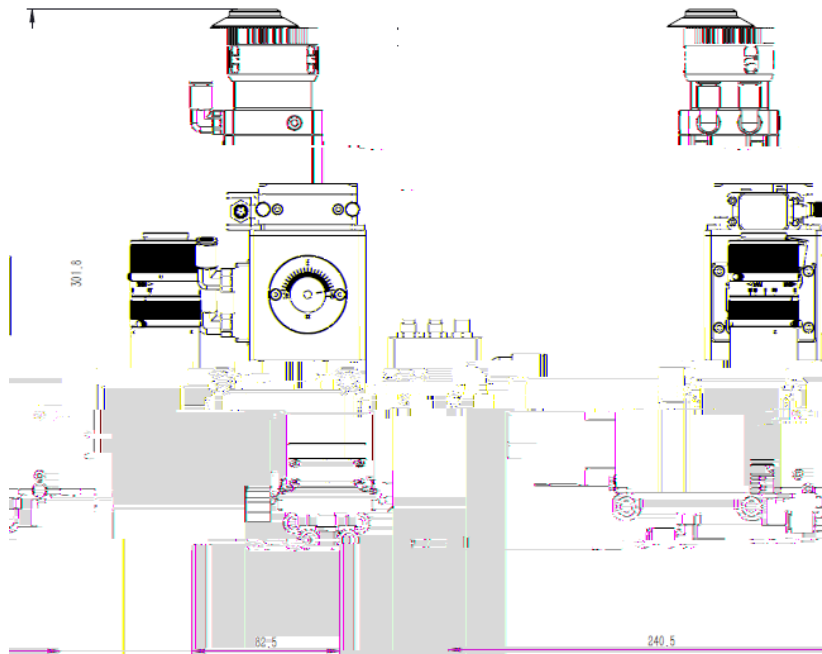

F100/ 90°

1.3

	BC04K
	1064nm
	4KW

QBH (), LOE3.1/QD/Q+

1.4

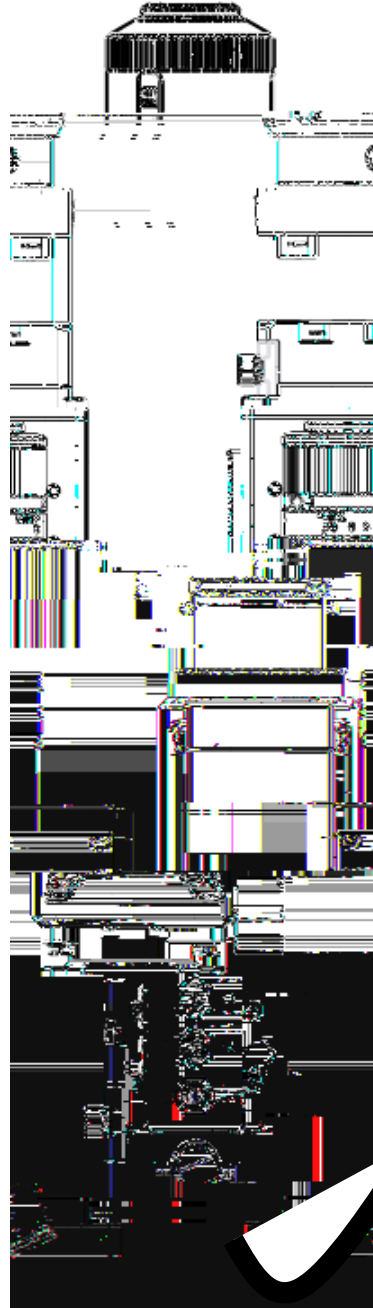

8

BC04K

1.5

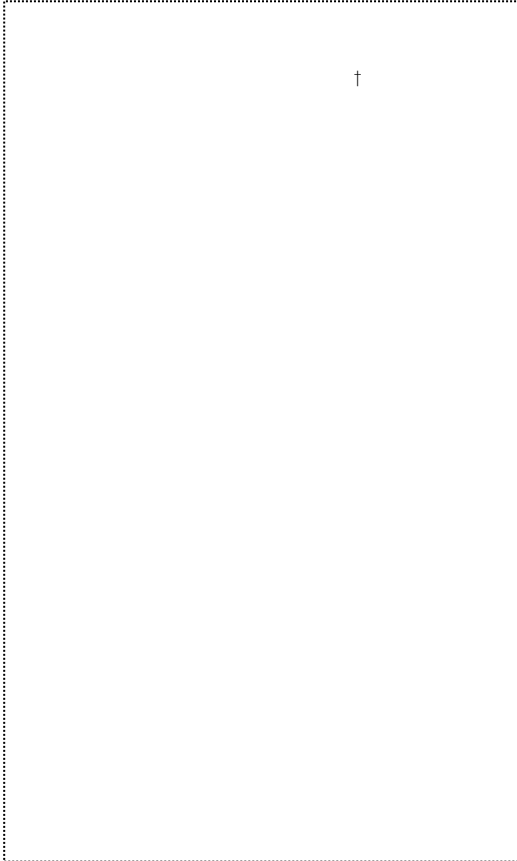

BC04K

1			
2		24-26	20-22
		28-30	24-26
3		20	
4		2-6	bar
5		2-4	L/min

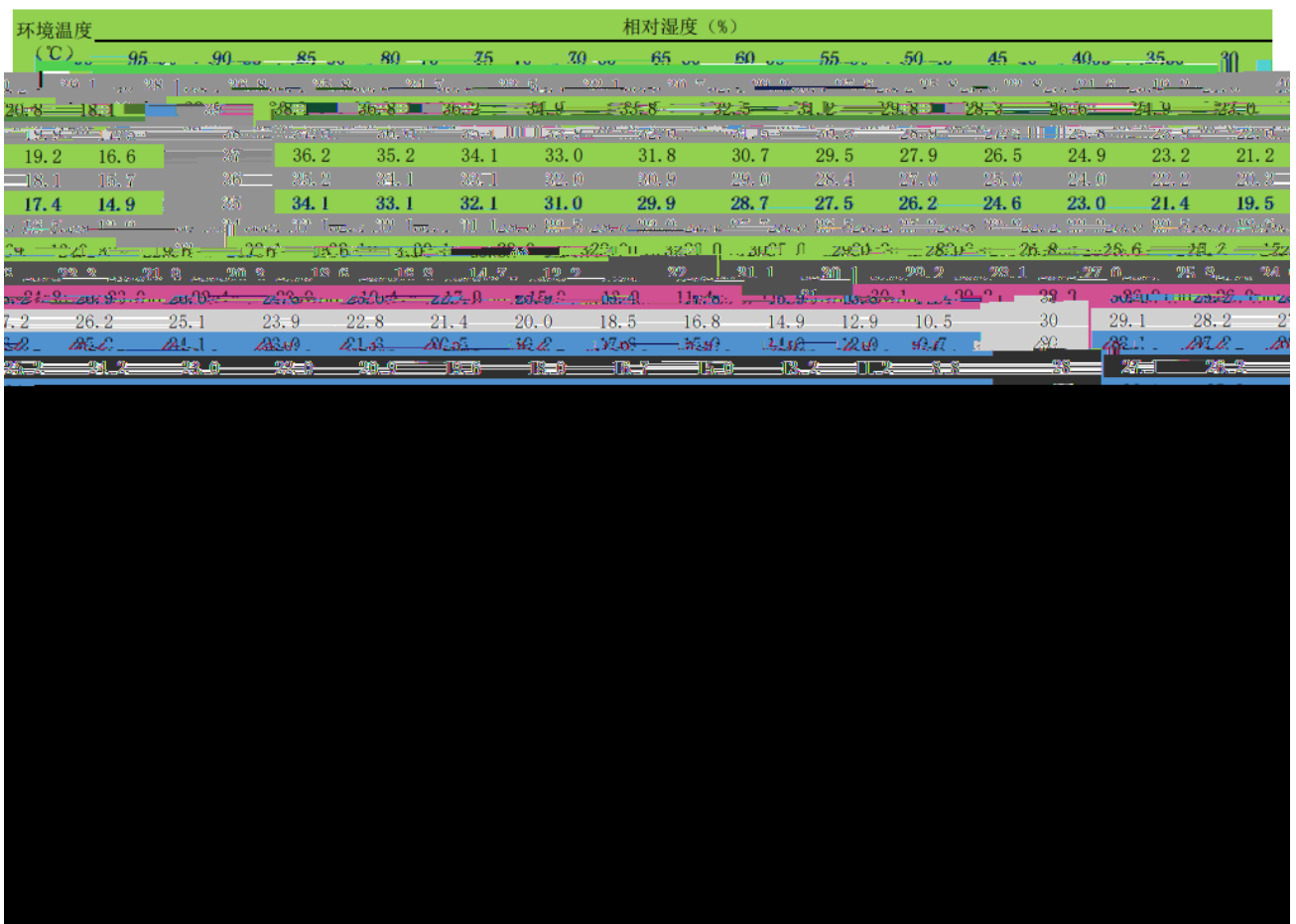

1.6



1.7

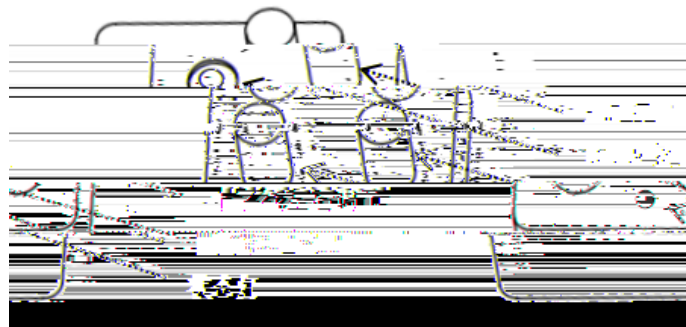
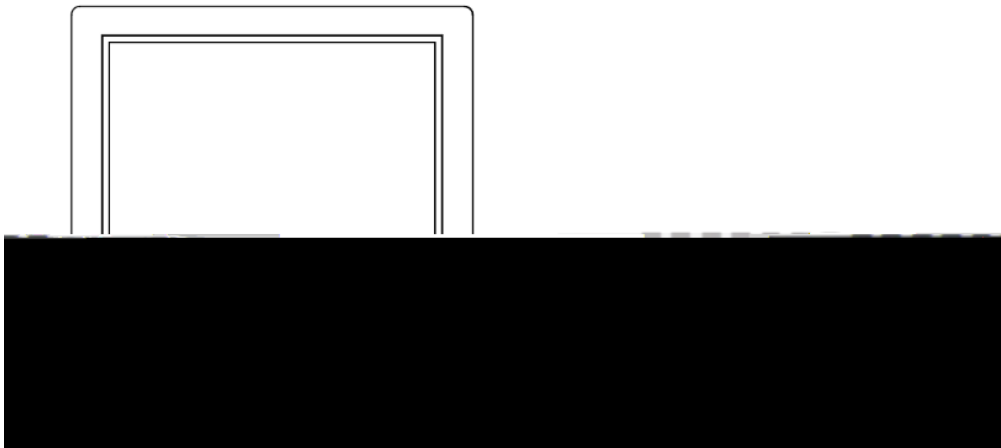
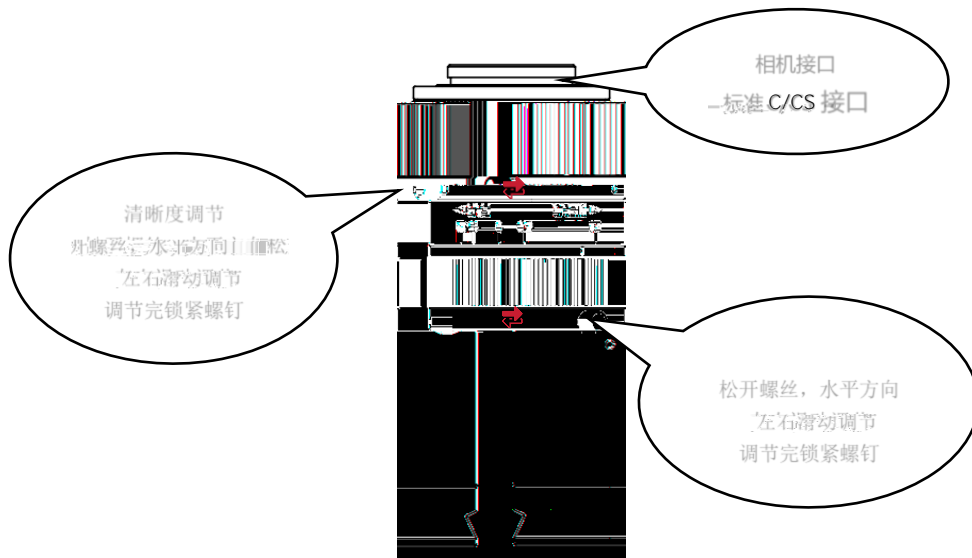

1.8

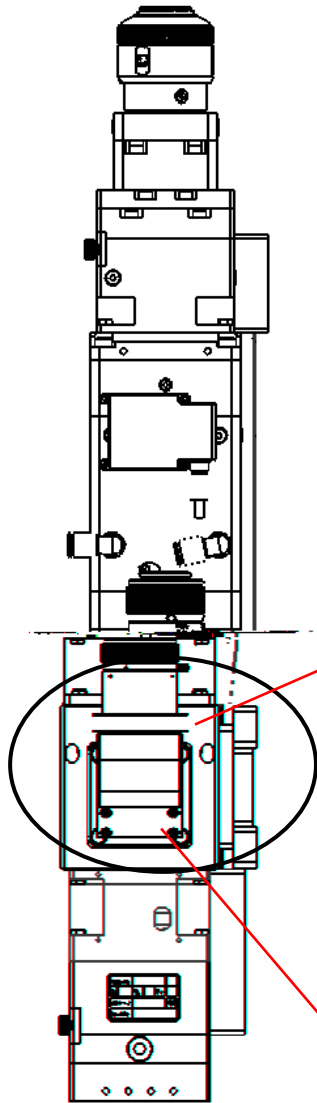

1

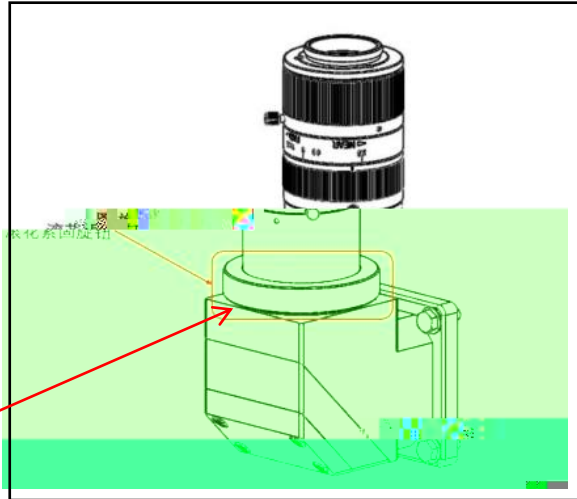

2

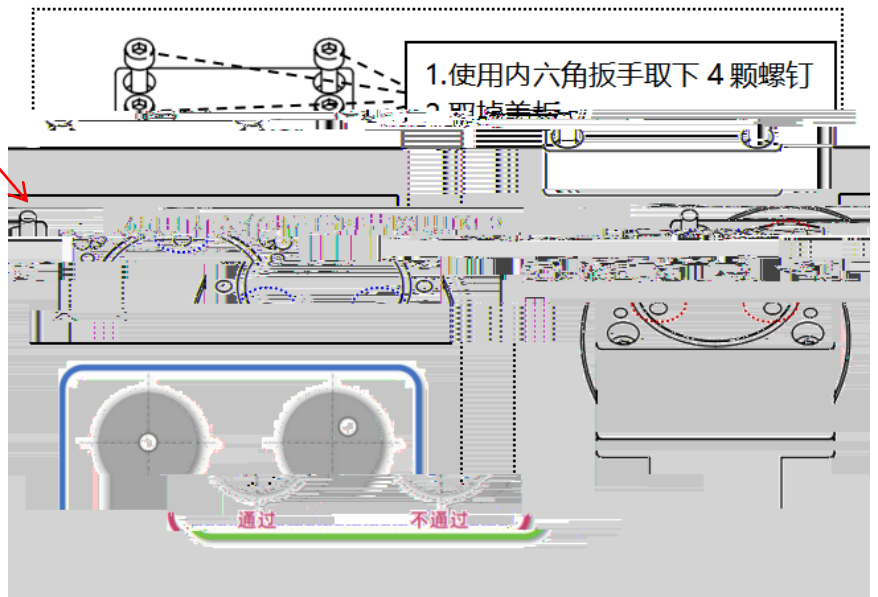

2.

2.1



2.2

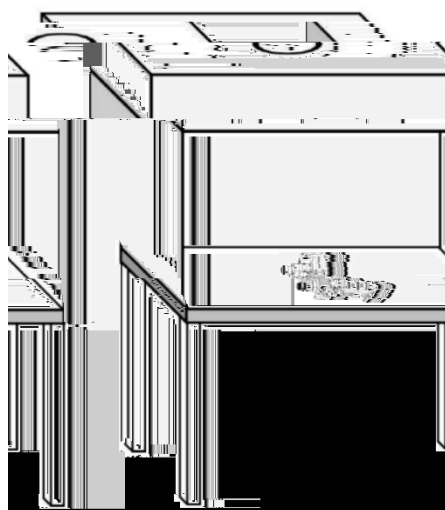

2.3

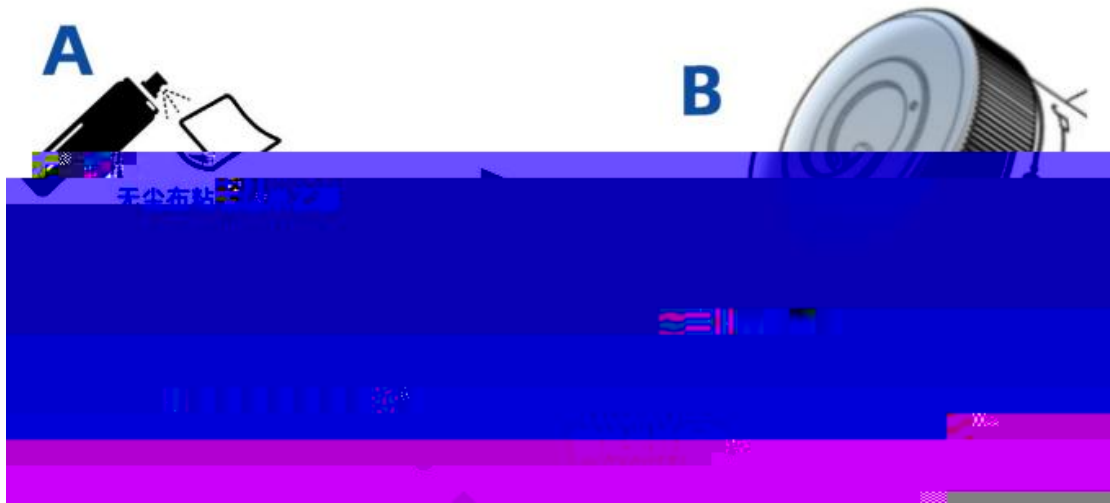

2.4



2.5

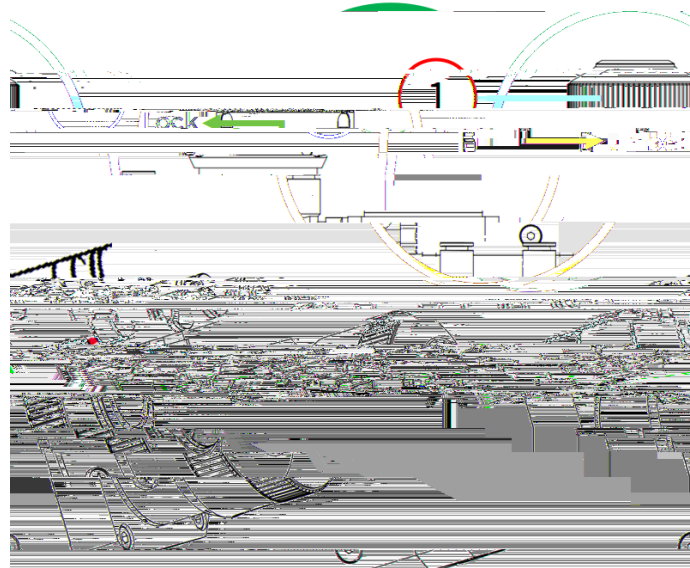

QBH

45°

45°

QBH

QBH

45°

45°

2.6



2.7



2.9

2.9.1



1

1/2/3/4

2

3

1/2/3/4

2.9.2





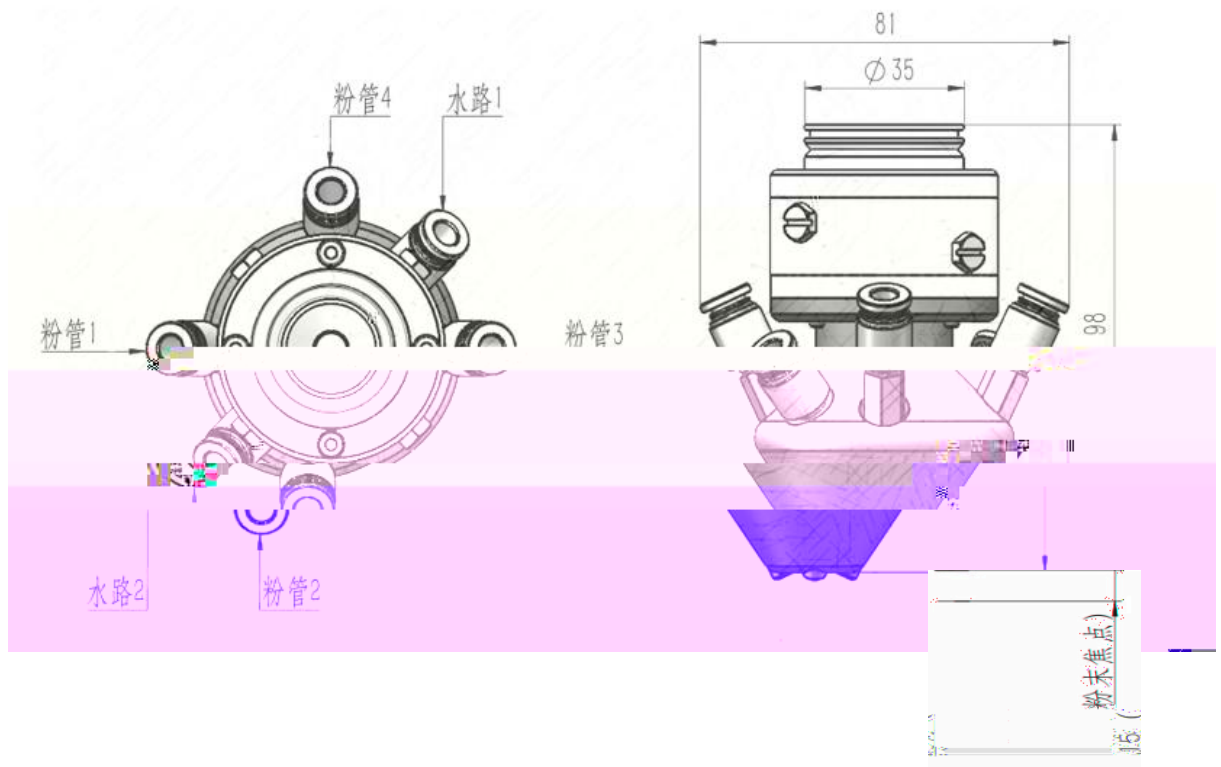

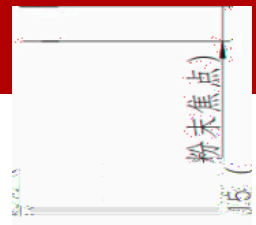
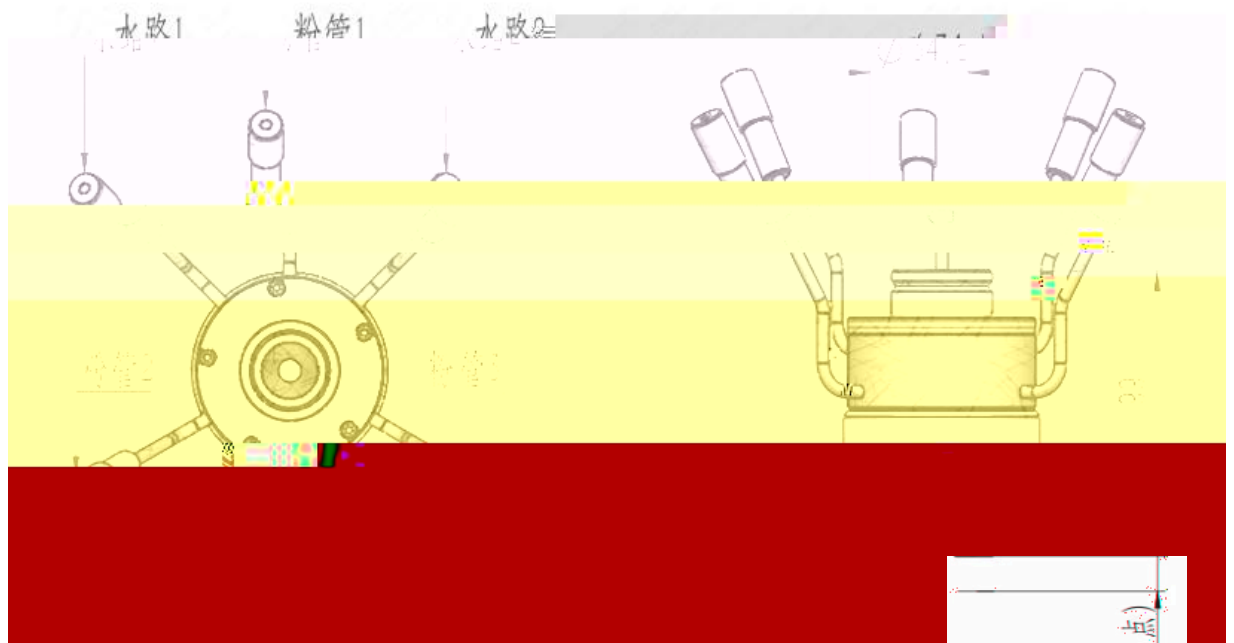

3.

3.1

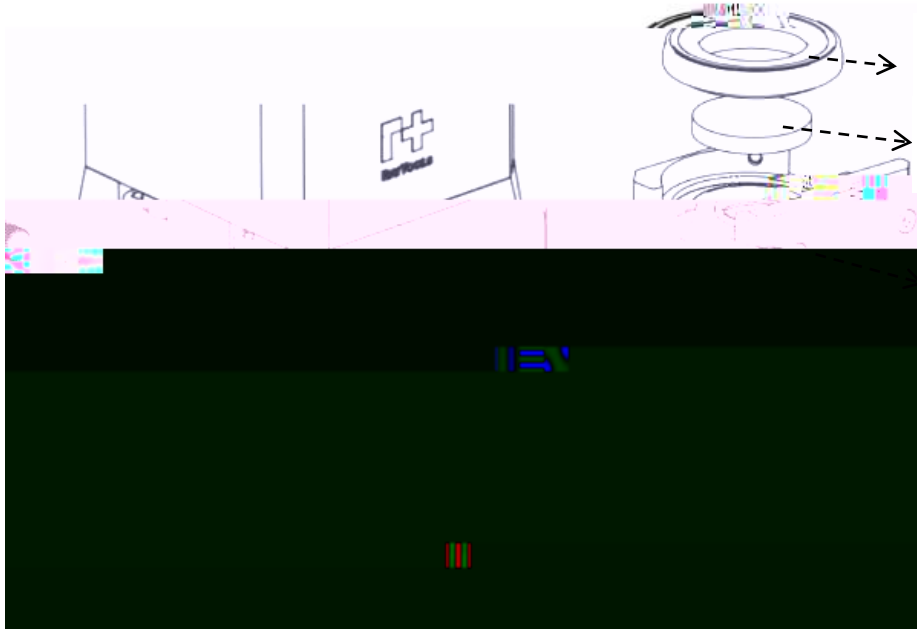

3.2

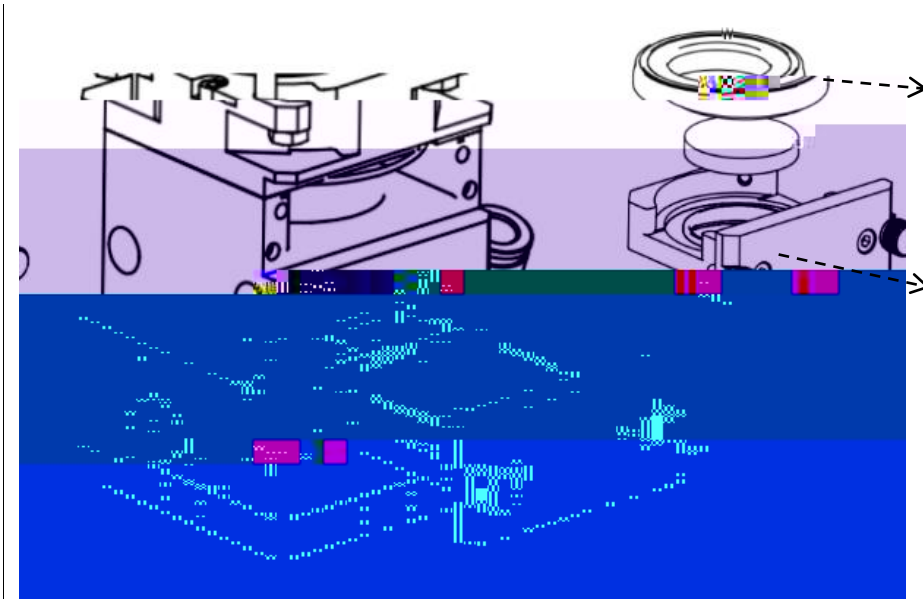

RAYTOOLS

