

**Empower 嘉强**

Hotline: 400-670-1510

Email: sales@empower.cn

Add: 上海市 松江区 东宝路 8 号



---



---

- 

- 

- 

- 

-



---

"7 y

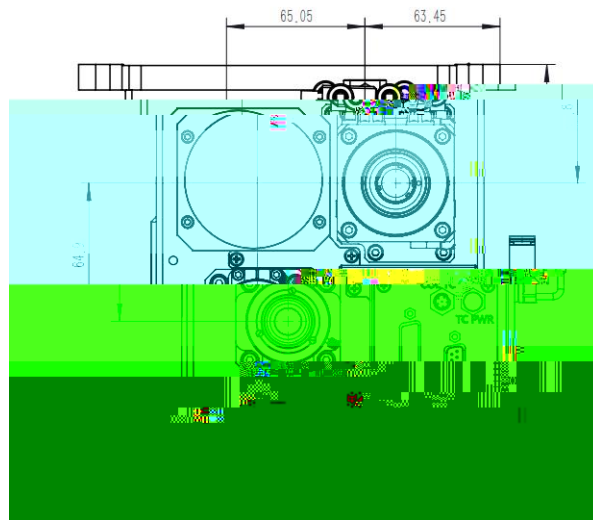
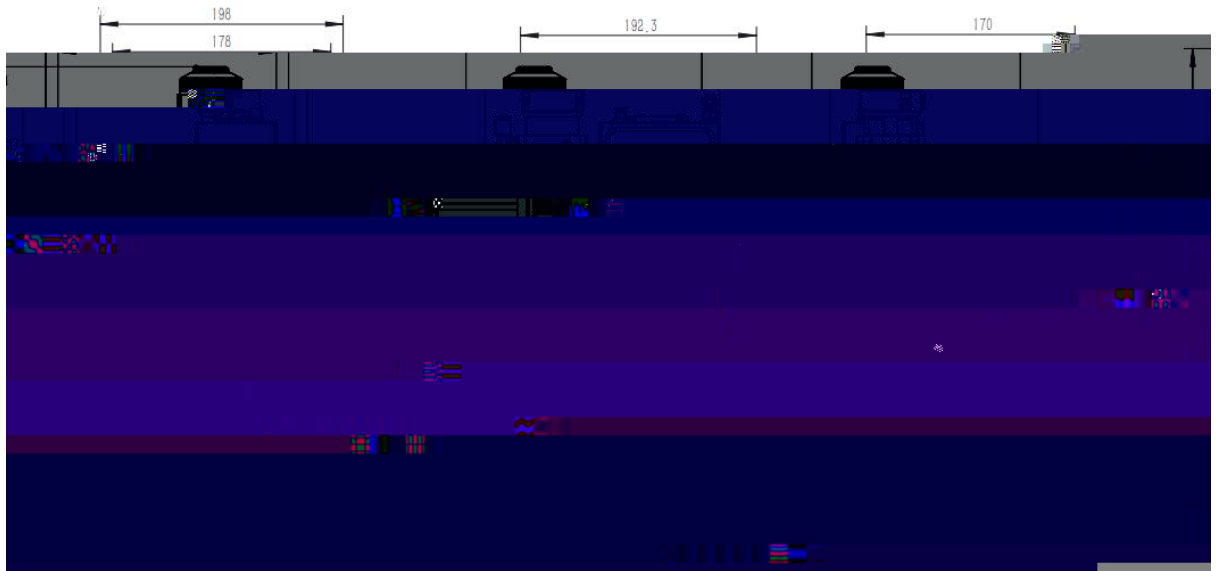





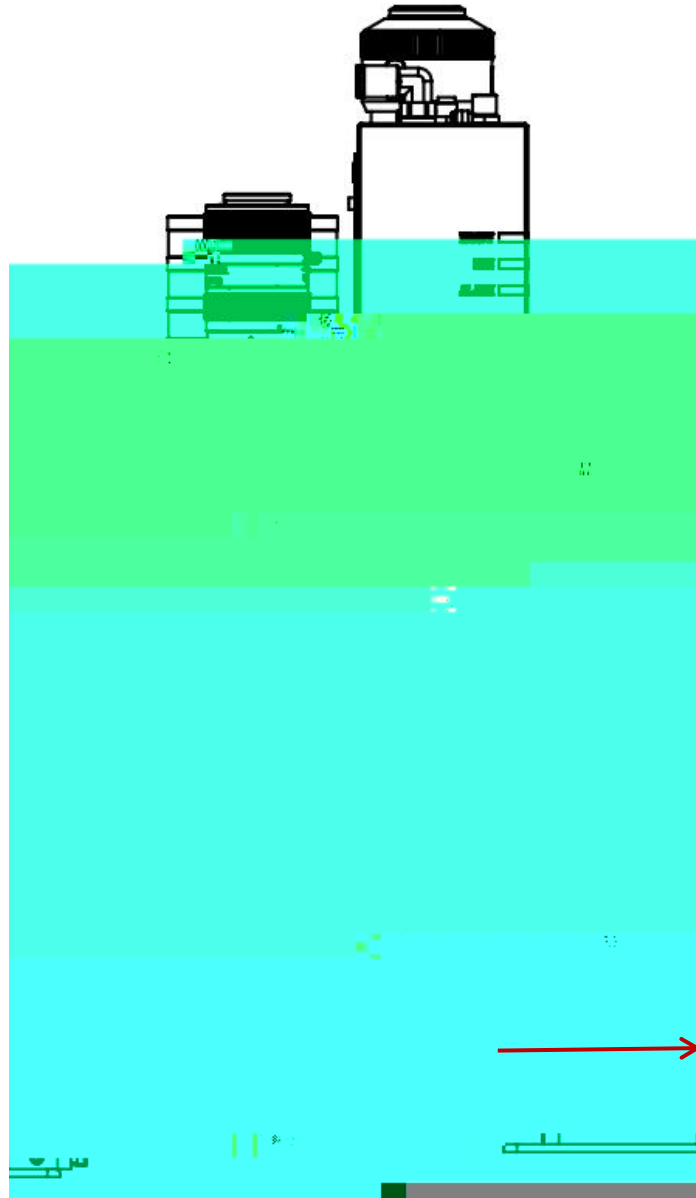

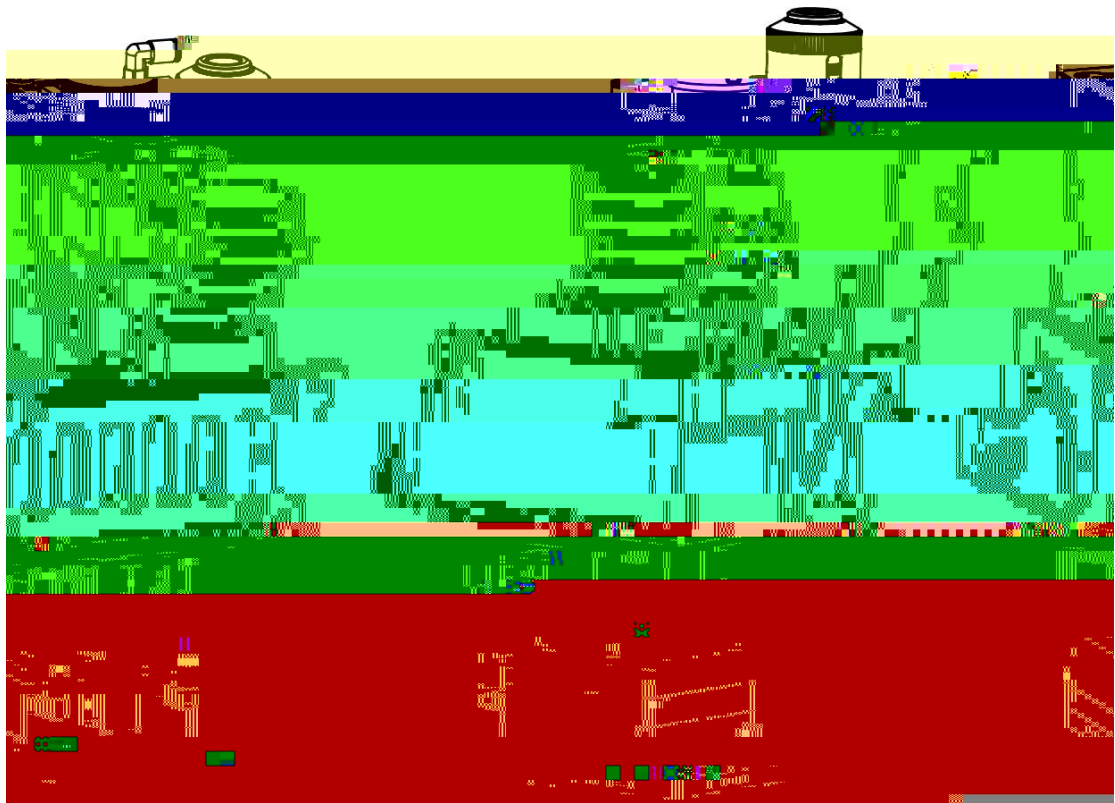



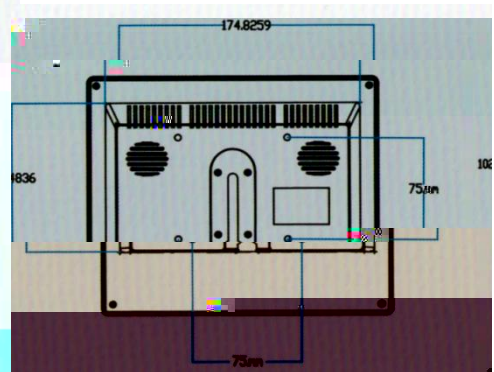
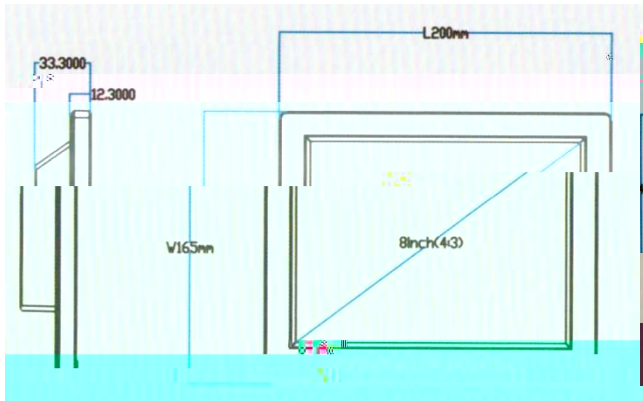
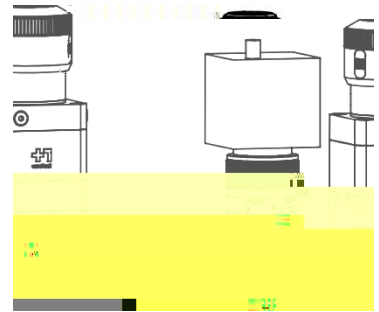
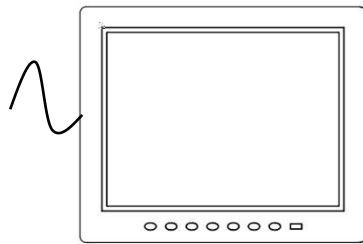



)"

†

†



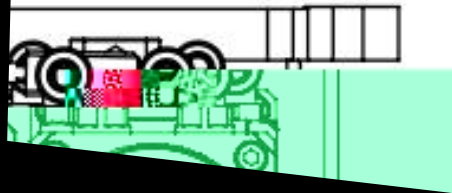

---

洁净工作台类型：垂直净化；洁

净等级：ISO 5级、10级

高纯气体应用



II

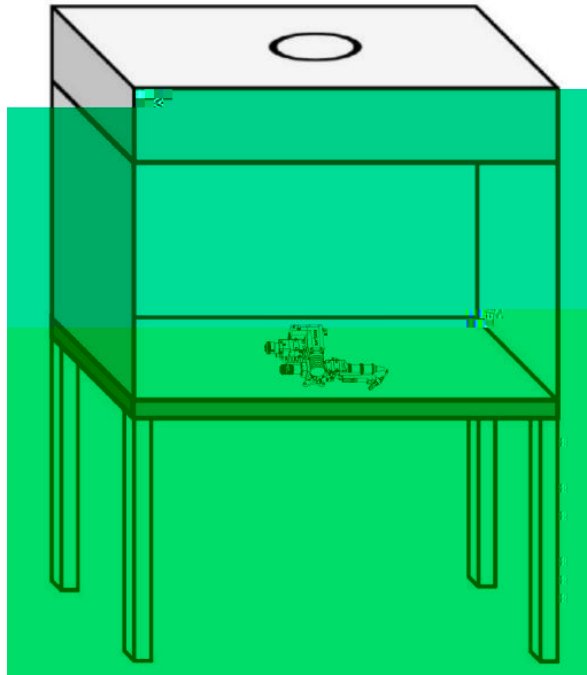

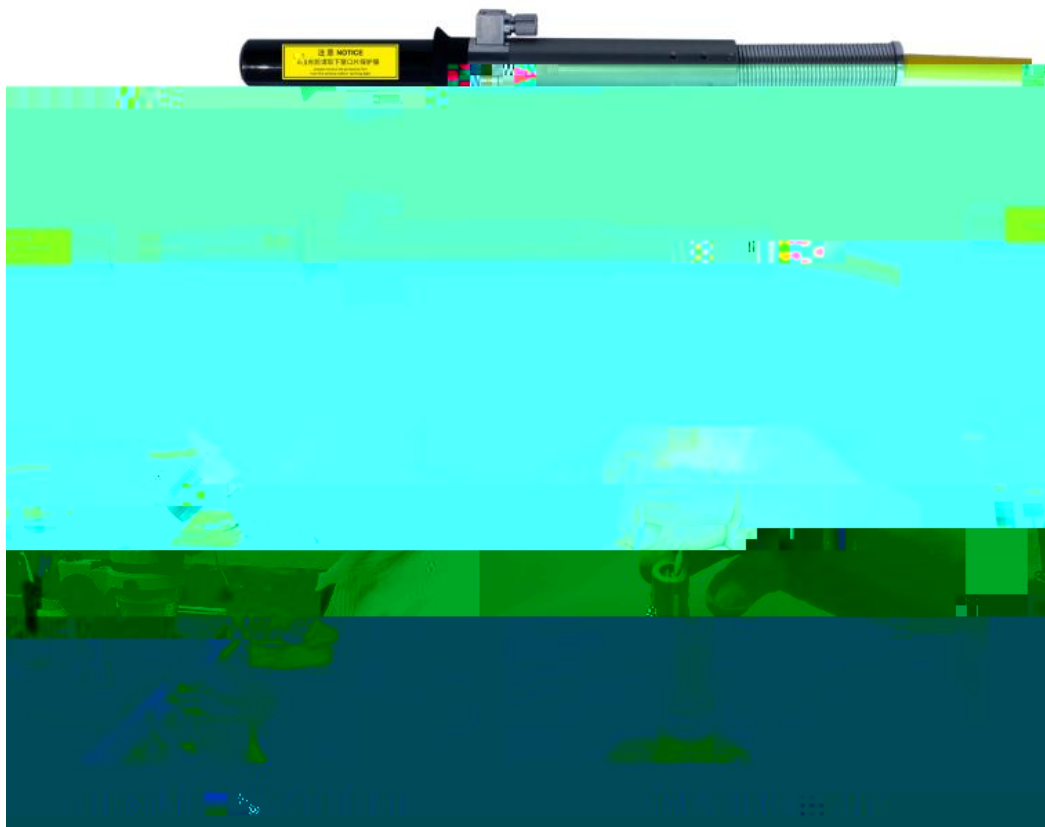
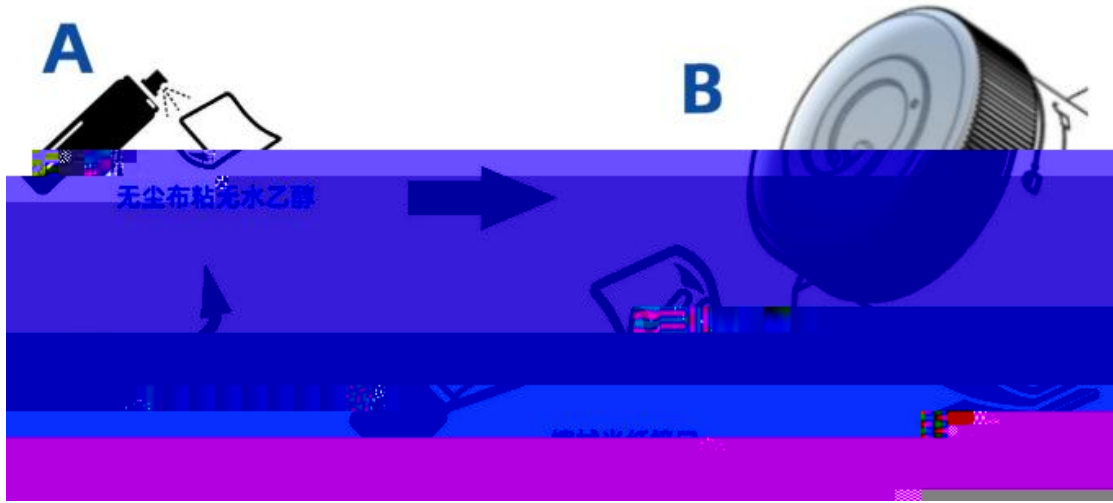

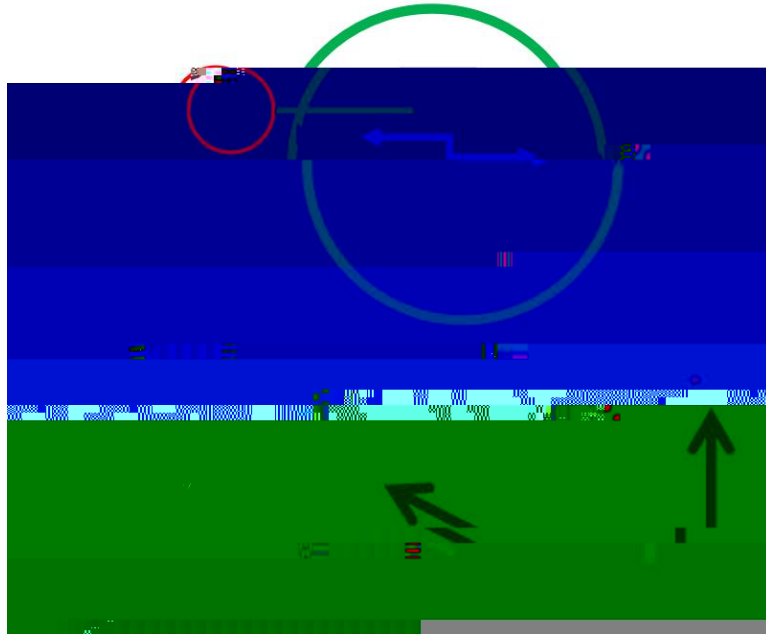

- 
- 
- 
- 
- 
- 

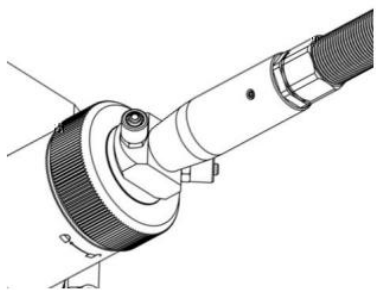

胶带缠绕密封

U

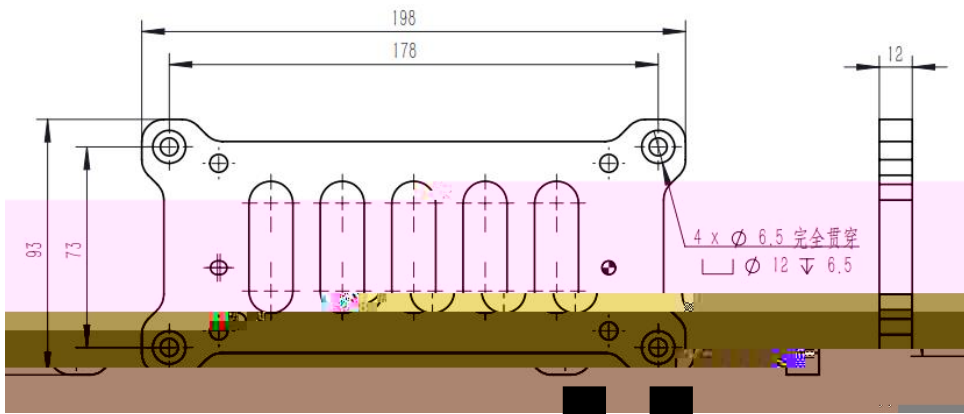
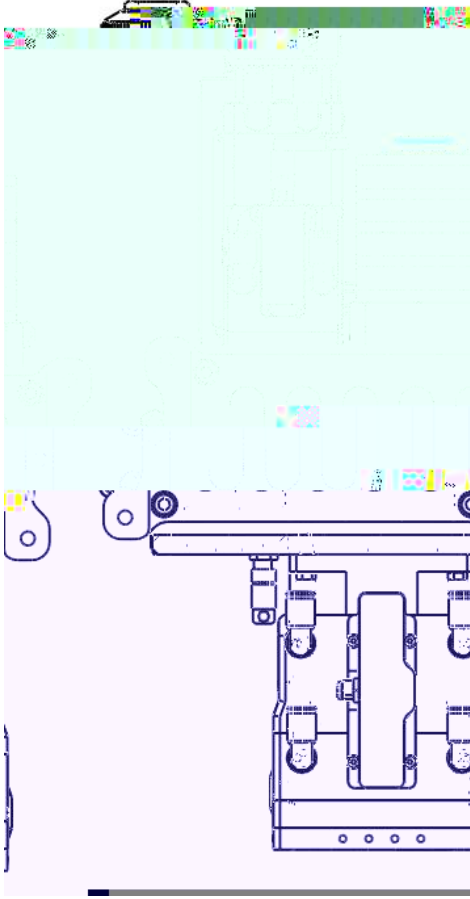

A

A

---

"7 y

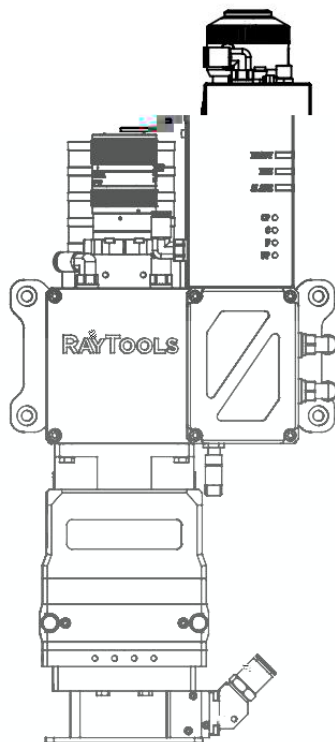
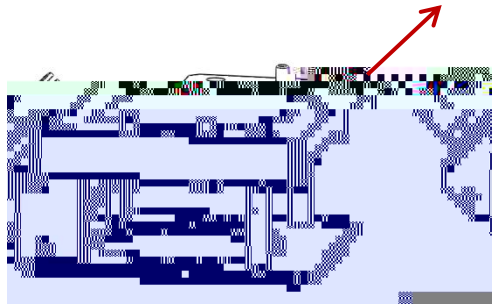

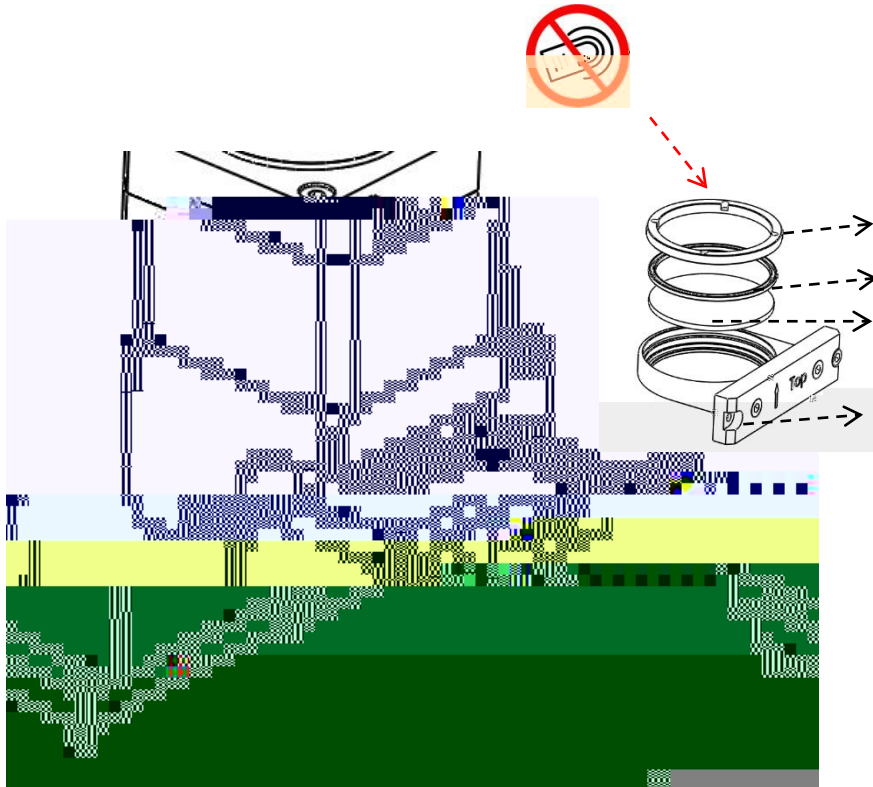

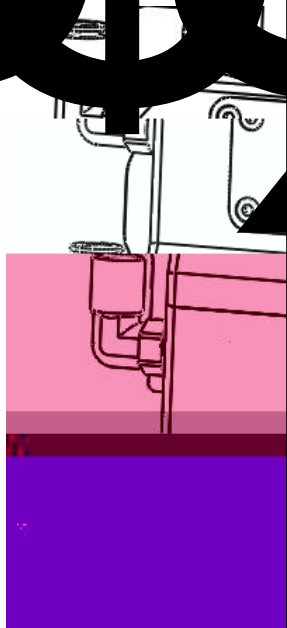

---











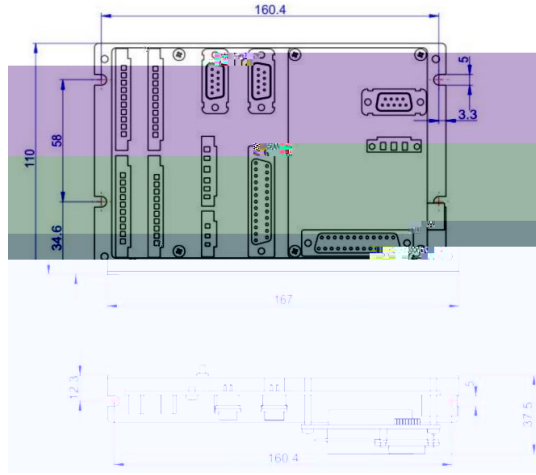

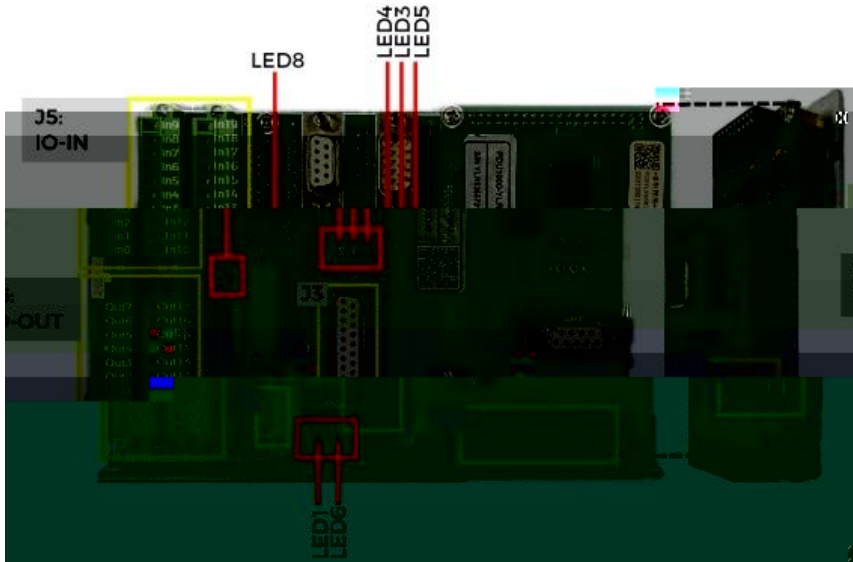
MM

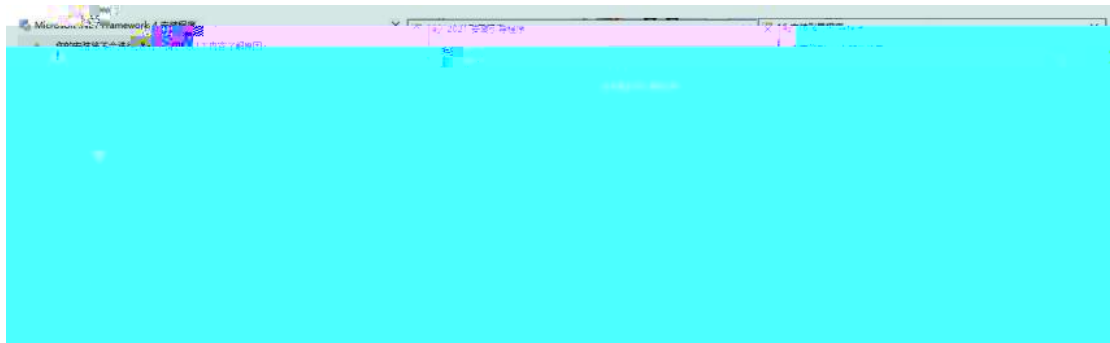

h) y 'O † M yo" †  
† †

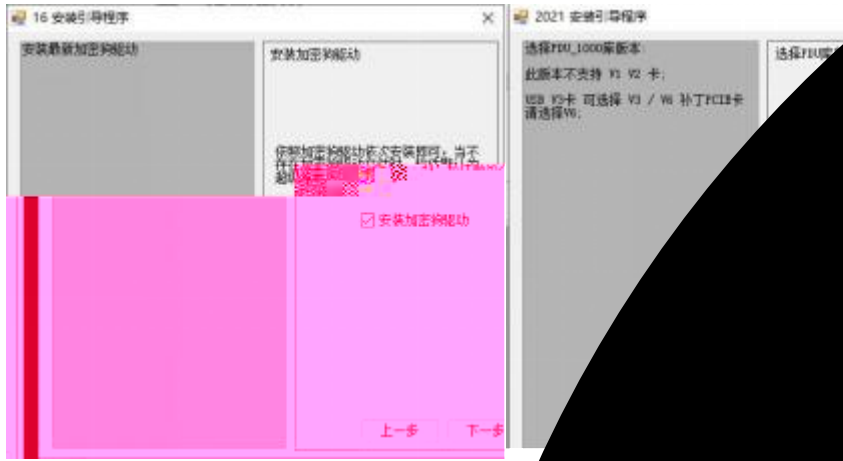

†

---



† † yo" †



h) y

) h) y

†

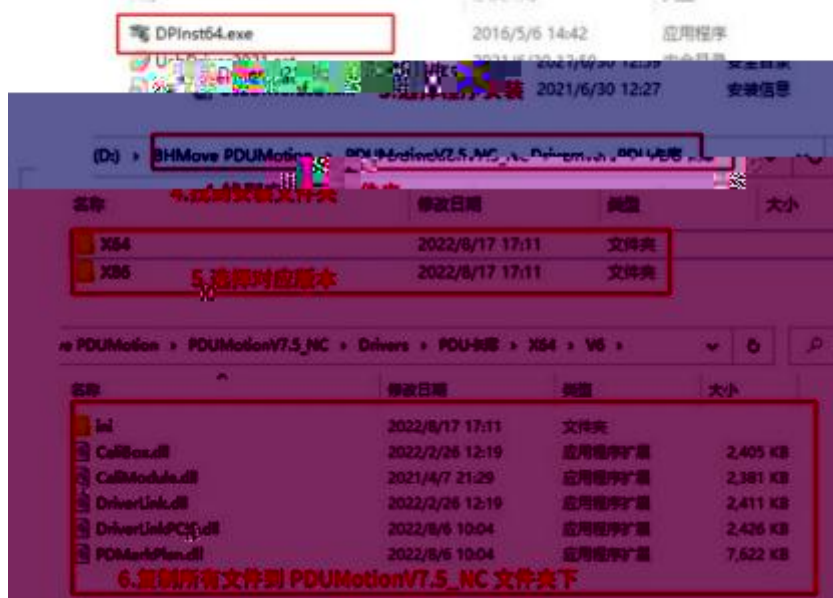
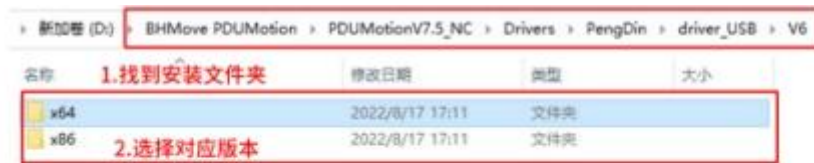



"\Œ





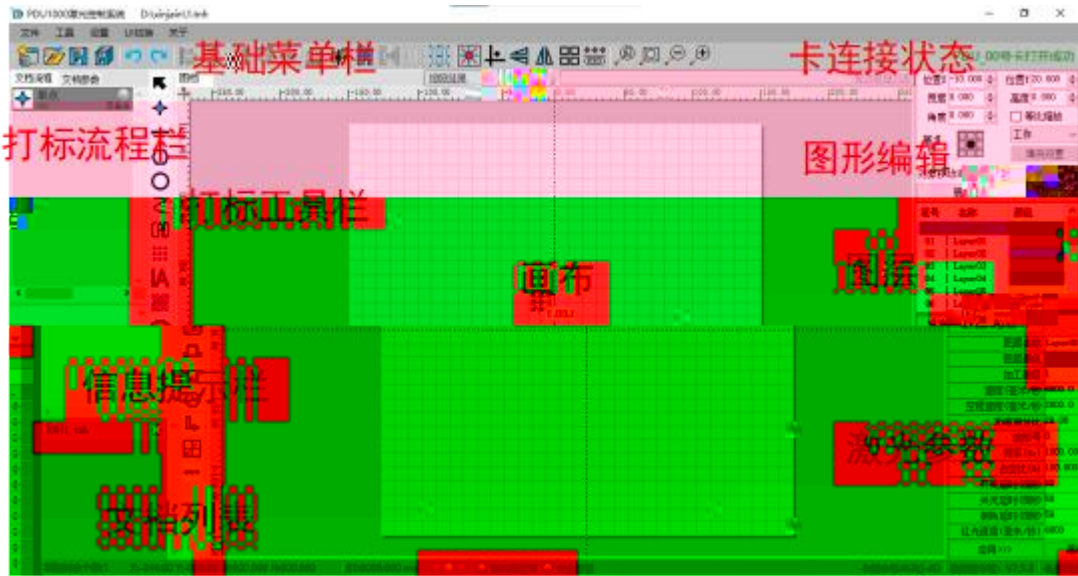



---

@

@

@

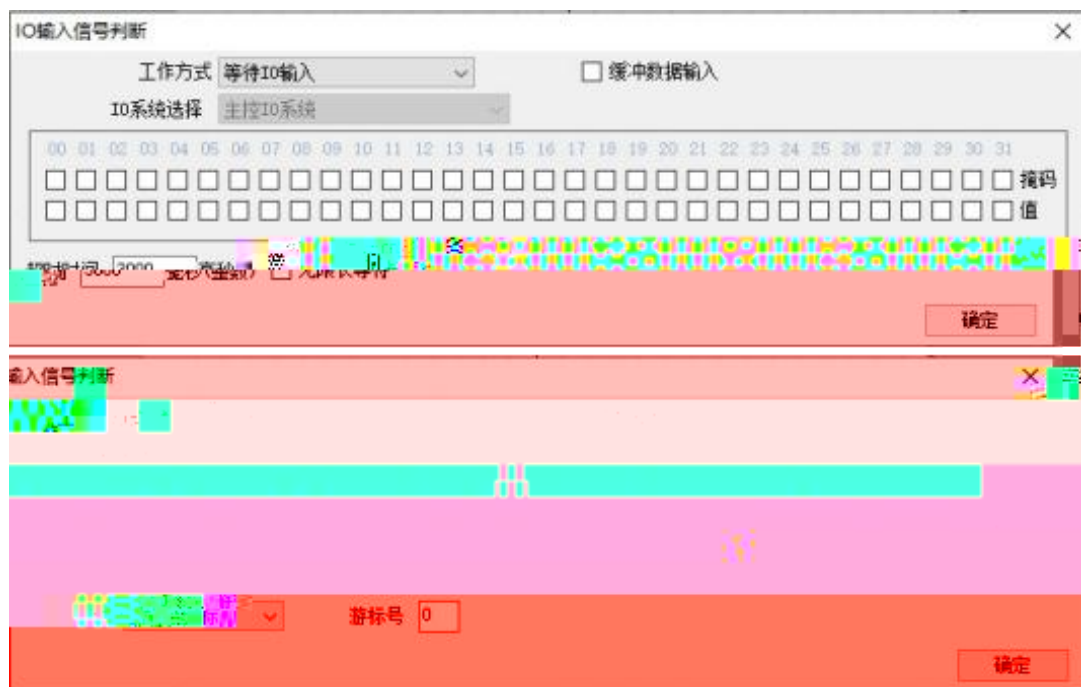

## 图层

笔号	名称	颜色
00	层参数00	红色
01	层参数01	绿色
02	层参数02	蓝色
03	层参数03	棕色
04	层参数04	深绿色
05	层参数05	黄色
06	层参数06	黑色
07	层参数07	深蓝色
08	层参数08	深紫色
09	层参数09	深红色
10	层参数10	深棕色
11	层参数11	深灰色
12	层参数12	深蓝色
13	层参数13	深紫色
14	层参数14	深红色
15	层参数15	深棕色
16	层参数16	深灰色
17	层参数17	深蓝色
18	层参数18	深紫色
19	层参数19	深红色
20	层参数20	深棕色
21	层参数21	深灰色
22	层参数22	深蓝色
23	层参数23	深紫色
24	层参数24	深红色
25	层参数25	深棕色
26	层参数26	深灰色
27	层参数27	深蓝色
28	层参数28	深紫色
29	层参数29	深红色
30	层参数30	深棕色
31	层参数31	深灰色

## 参数

设为默认参数>>>

图层名称	层参数00
图层颜色	红色 编辑
加工数目	1
速度(毫米/秒)	200.0
进给速度(毫米/秒)	4000.0
功率百分比	50.00
波形号	0
频率(Hz)	0.000
占空比(%)	50.000
开光延时(微秒)	60
关光延时(微秒)	120
拐角半径	0.000

- 
- 
- 
- 
- 
- 
- 
- 
- 

加工参数设置

基本参数	单位/格式	数据类型
打印时间	2000	毫秒
最大刻线频率	2000	毫秒
最小刻线频率	500	毫秒
最大刻线频率	20,000	毫米

位置控制 0 毫秒  
位置控制时间

位置控制时间 0.0

单位时间 20,000 毫秒(ms)

基本刻线频率 0,000 毫米

平均输出方式 浮点数  
输出单位 0,000

控制输出数据类型 时间

确定 取消

- 
- 
- 
- 
- 
- 
- 
- 
-

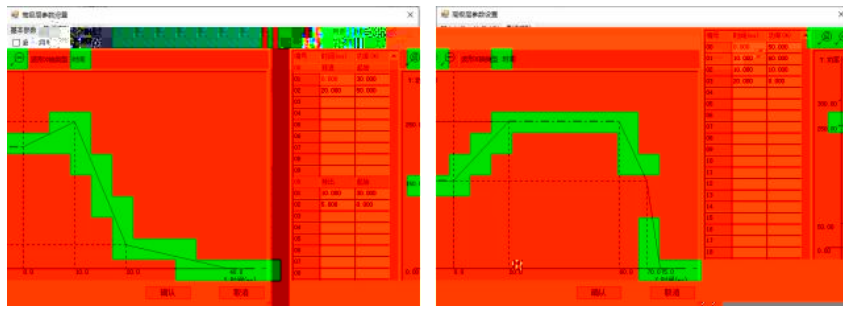

Uo

---



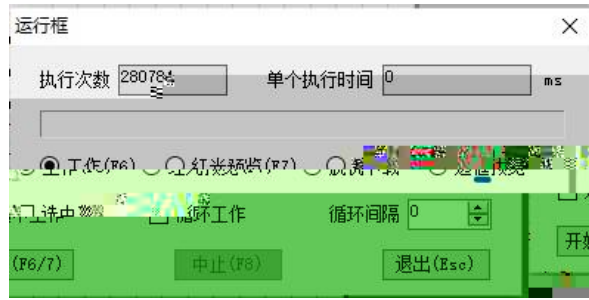

- 
- 
- 
- 
- 
- 
- 
- 

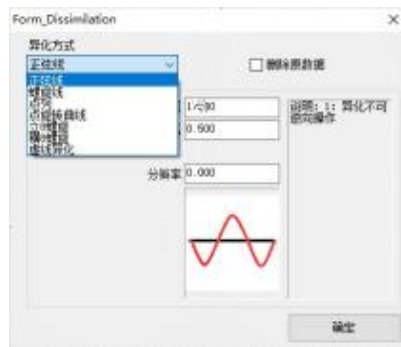

- 
- 
-



- 
- 

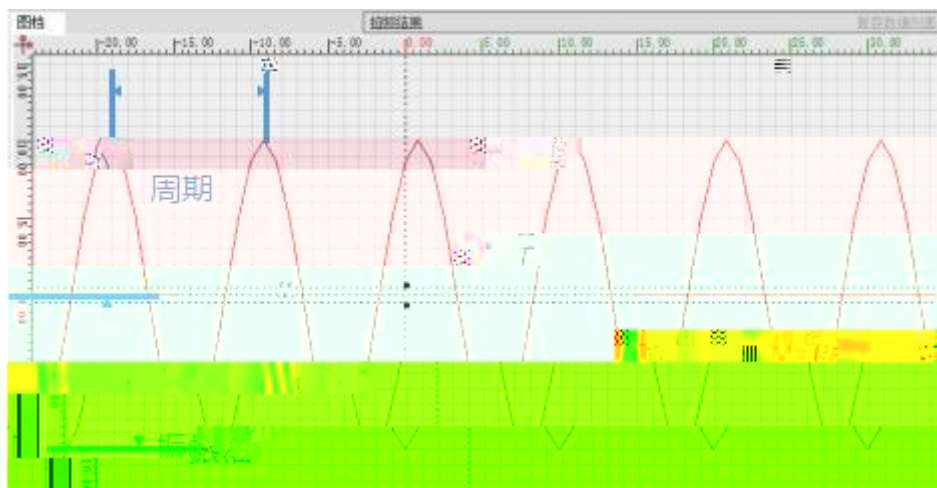

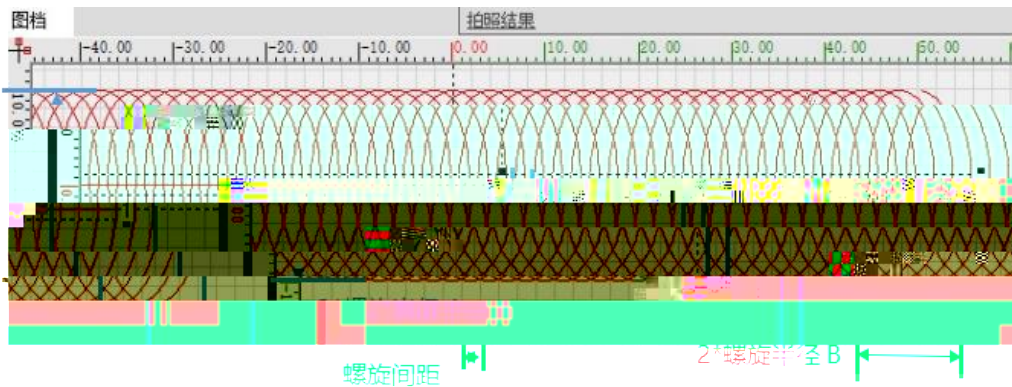
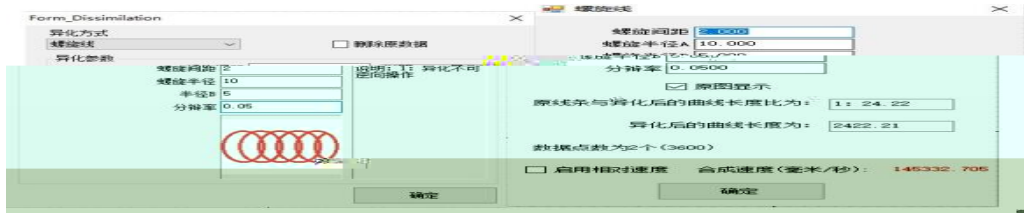

●

●

●

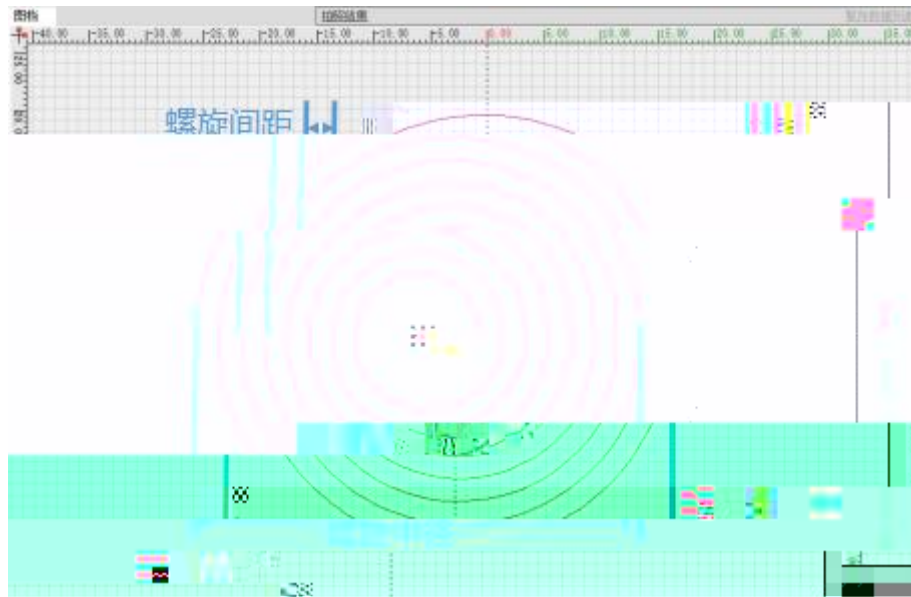

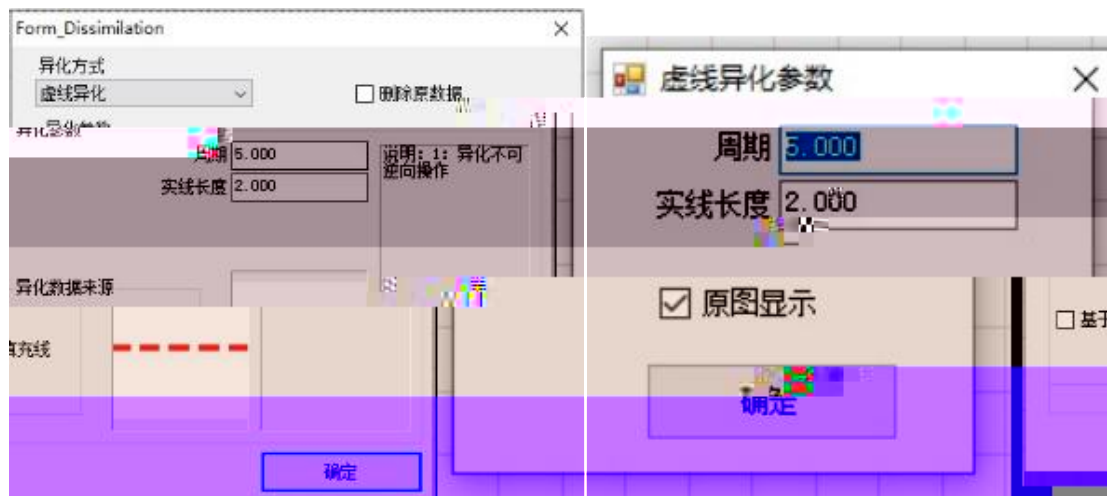
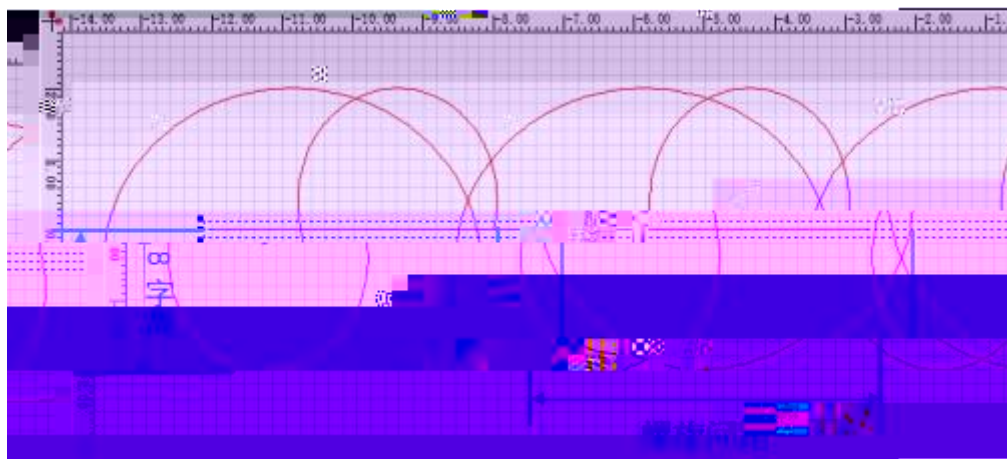
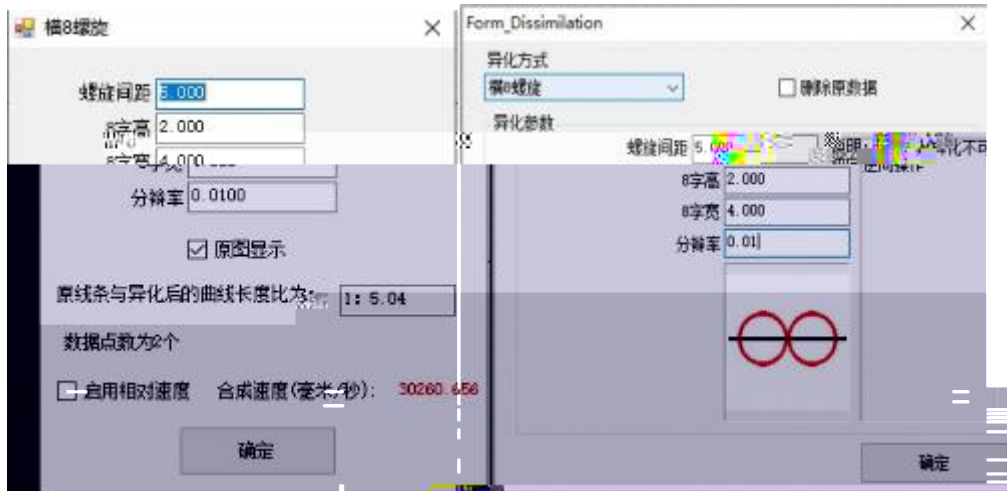





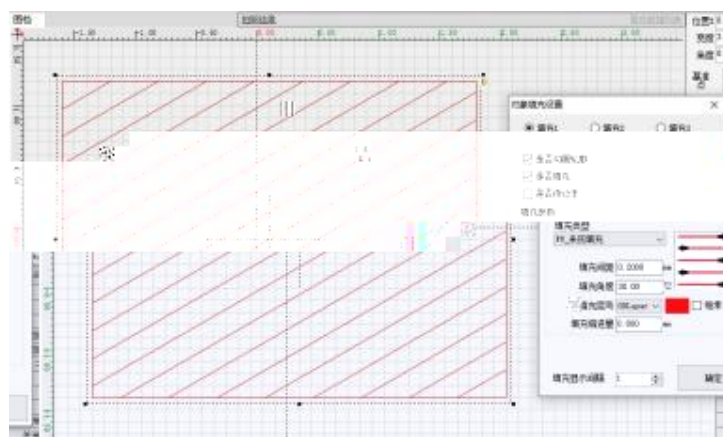
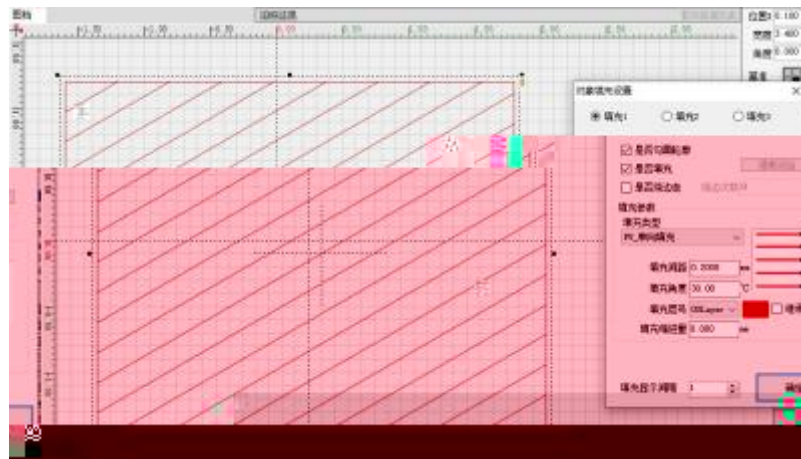
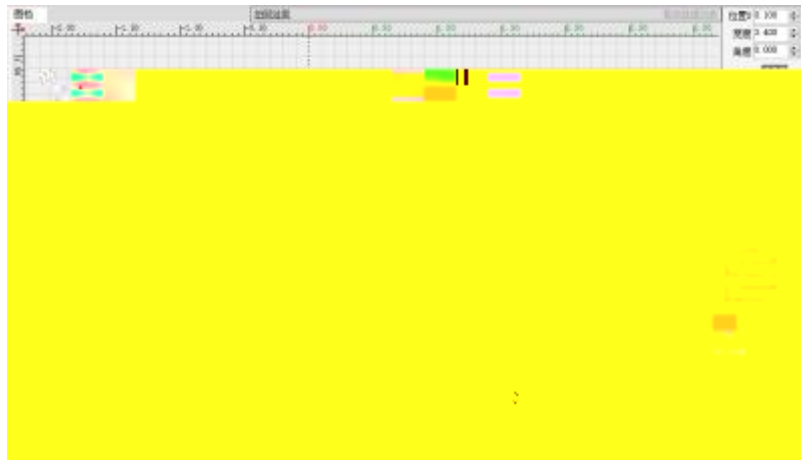

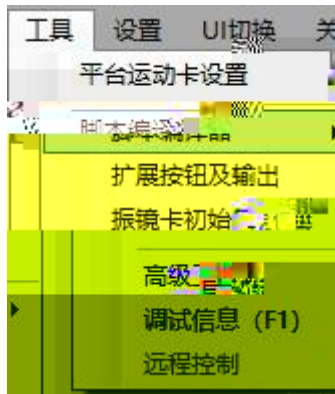
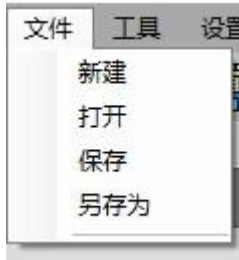

●

●

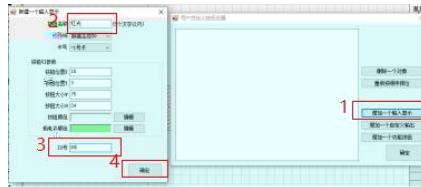

●





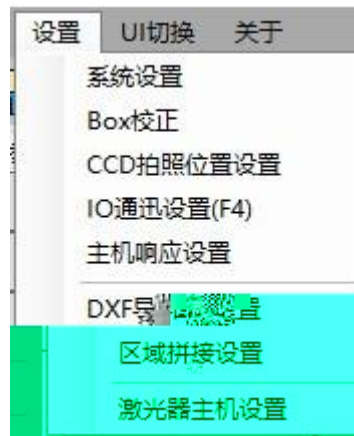

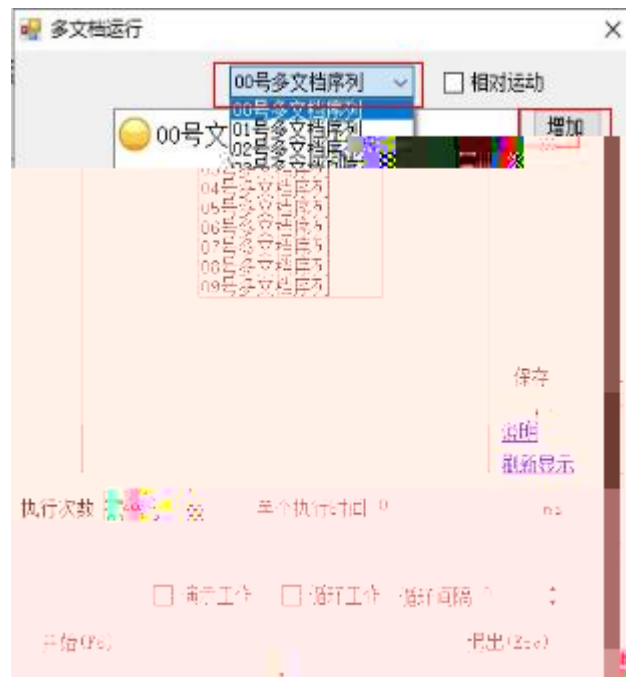
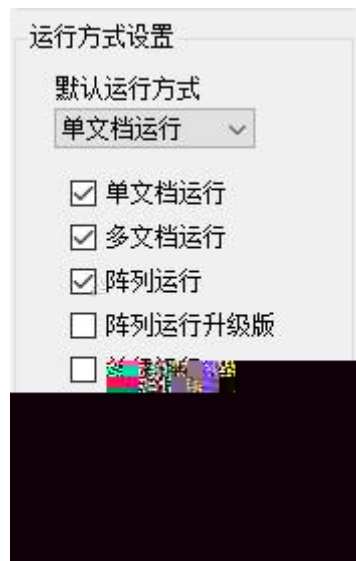

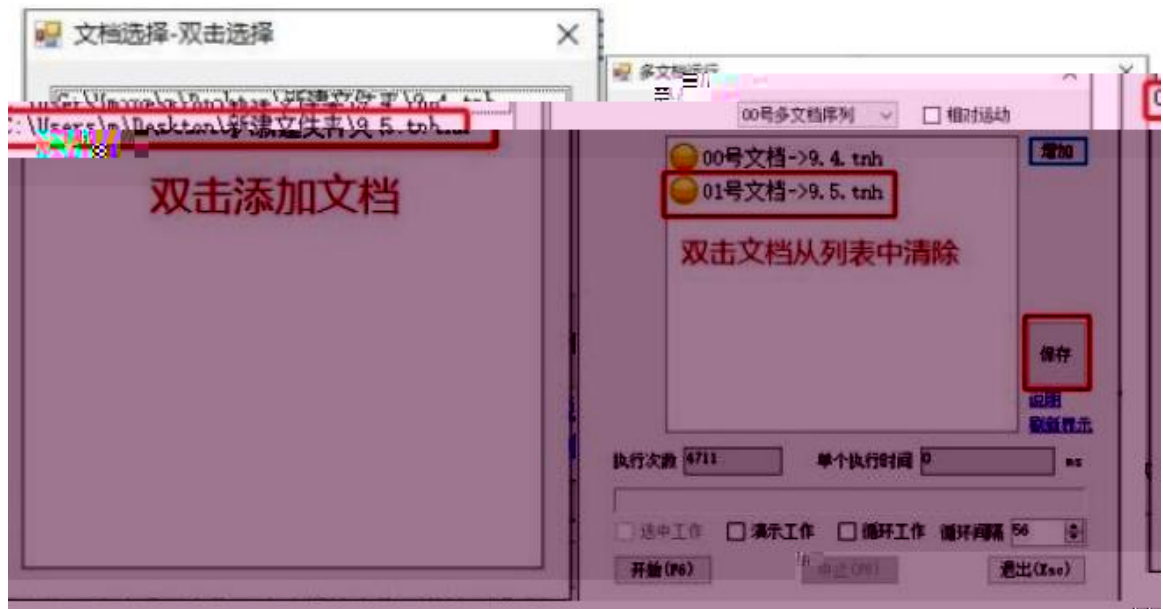

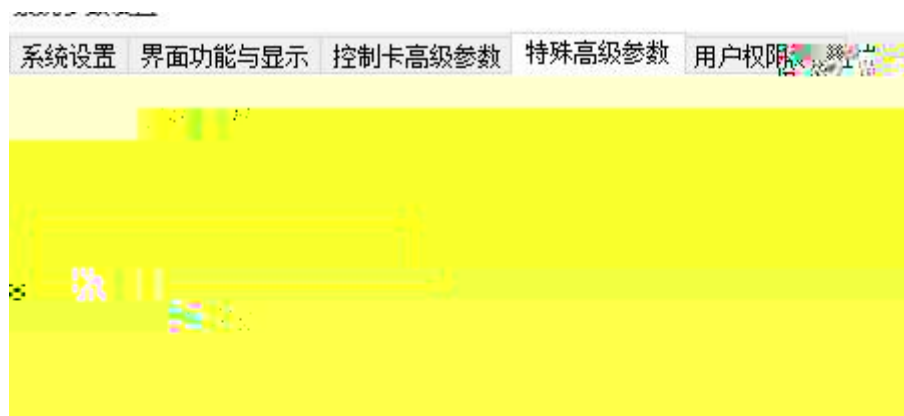





h) y

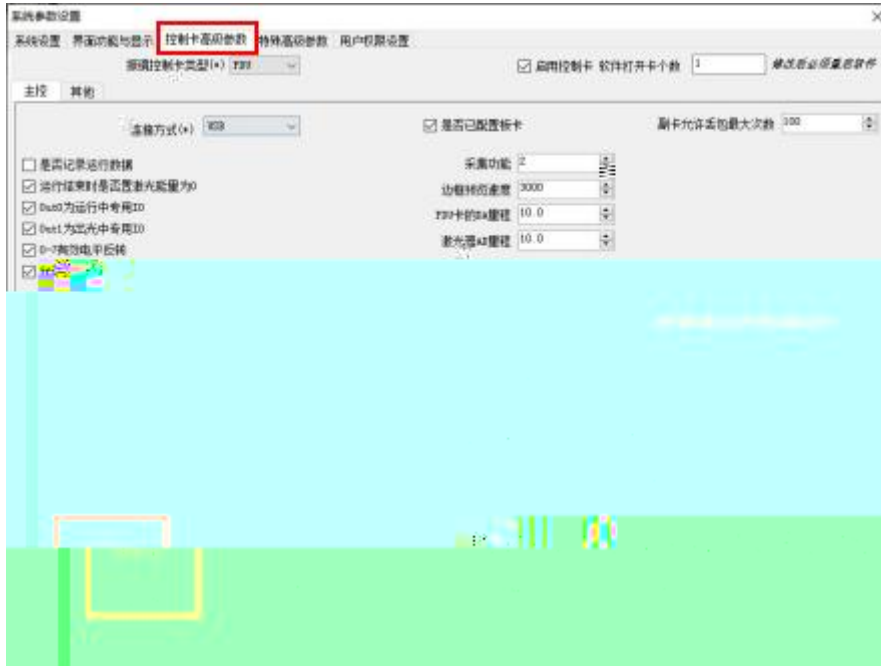

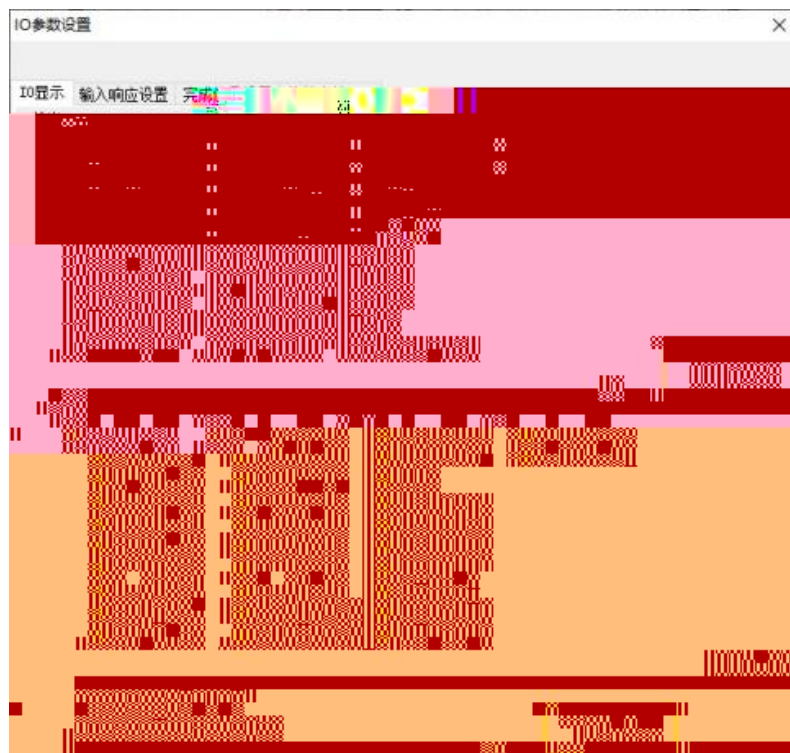

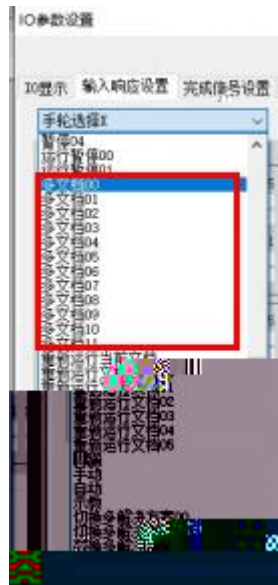



事件名称 10 输入点设置

00	01	02	03	04	05	06	07	08	09	10	11	12	13	14	15	插码值
<input type="checkbox"/>	<input checked="" type="checkbox"/>	<input checked="" type="checkbox"/>	<input checked="" type="checkbox"/>	<input checked="" type="checkbox"/>	<input checked="" type="checkbox"/>	<input type="checkbox"/>	<input type="checkbox"/>	<input type="checkbox"/>	<input type="checkbox"/>	<input type="checkbox"/>	<input type="checkbox"/>	<input type="checkbox"/>	<input type="checkbox"/>	<input type="checkbox"/>	<input type="checkbox"/>	

多文档 01

输入

00	01	02	03	04	05	06	07	08	09	10	11	12	13	14	15	插码值
<input type="checkbox"/>	<input checked="" type="checkbox"/>	<input checked="" type="checkbox"/>	<input checked="" type="checkbox"/>	<input checked="" type="checkbox"/>	<input checked="" type="checkbox"/>	<input type="checkbox"/>	<input type="checkbox"/>	<input type="checkbox"/>	<input type="checkbox"/>	<input type="checkbox"/>	<input type="checkbox"/>	<input type="checkbox"/>	<input type="checkbox"/>	<input type="checkbox"/>	<input type="checkbox"/>	
16	17	18	19	20	21	22	23	24	25	26	27	28	29	30	31	插码值
<input type="checkbox"/>	<input type="checkbox"/>	<input type="checkbox"/>	<input type="checkbox"/>	<input type="checkbox"/>	<input type="checkbox"/>	<input type="checkbox"/>	<input type="checkbox"/>	<input type="checkbox"/>	<input type="checkbox"/>	<input type="checkbox"/>	<input type="checkbox"/>	<input type="checkbox"/>	<input type="checkbox"/>	<input type="checkbox"/>	<input type="checkbox"/>	

多文档 02

输入

00	01	02	03	04	05	06	07	08	09	10	11	12	13	14	15	插码值
<input type="checkbox"/>	<input checked="" type="checkbox"/>	<input checked="" type="checkbox"/>	<input checked="" type="checkbox"/>	<input checked="" type="checkbox"/>	<input checked="" type="checkbox"/>	<input type="checkbox"/>	<input type="checkbox"/>	<input type="checkbox"/>	<input type="checkbox"/>	<input type="checkbox"/>	<input type="checkbox"/>	<input type="checkbox"/>	<input type="checkbox"/>	<input type="checkbox"/>	<input type="checkbox"/>	
16	17	18	19	20	21	22	23	24	25	26	27	28	29	30	31	插码值
<input type="checkbox"/>	<input type="checkbox"/>	<input type="checkbox"/>	<input type="checkbox"/>	<input type="checkbox"/>	<input type="checkbox"/>	<input type="checkbox"/>	<input type="checkbox"/>	<input type="checkbox"/>	<input type="checkbox"/>	<input type="checkbox"/>	<input type="checkbox"/>	<input type="checkbox"/>	<input type="checkbox"/>	<input type="checkbox"/>	<input type="checkbox"/>	



多文档 03

多文档 04

多文档 05

多文档 06

多文档 07

多文档 08

多文档 09

多文档 10

多文档 11

多文档 12

多文档 13

多文档 14

多文档 15

多文档 16

多文档 17

多文档 18

多文档 19

多文档 20

多文档 21

多文档 22

多文档 23

多文档 24

多文档 25

多文档 26

多文档 27

多文档 28

多文档 29

多文档 30

多文档 31

多文档 32

多文档 33

多文档 34

多文档 35

多文档 36

多文档 37

多文档 38

多文档 39

多文档 40

多文档 41

多文档 42

多文档 43

多文档 44

多文档 45

多文档 46

多文档 47

多文档 48

多文档 49

多文档 50

多文档 51

多文档 52

多文档 53

多文档 54

多文档 55

多文档 56

多文档 57

多文档 58

多文档 59

多文档 60

多文档 61

多文档 62

多文档 63

多文档 64

多文档 65

多文档 66

多文档 67

多文档 68

多文档 69

多文档 70

多文档 71

多文档 72

多文档 73

多文档 74

多文档 75

多文档 76

多文档 77

多文档 78

多文档 79

多文档 80

多文档 81

多文档 82

多文档 83

多文档 84

多文档 85

多文档 86

多文档 87

多文档 88

多文档 89

多文档 90

多文档 91

多文档 92

多文档 93

多文档 94

多文档 95

多文档 96

多文档 97

多文档 98

多文档 99

多文档 100



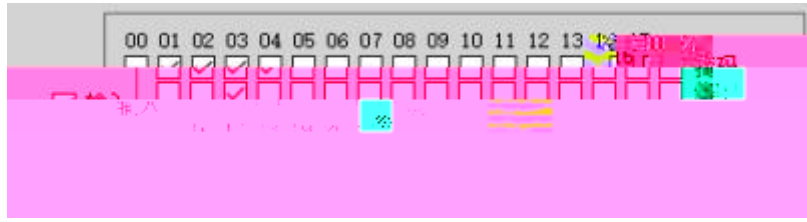

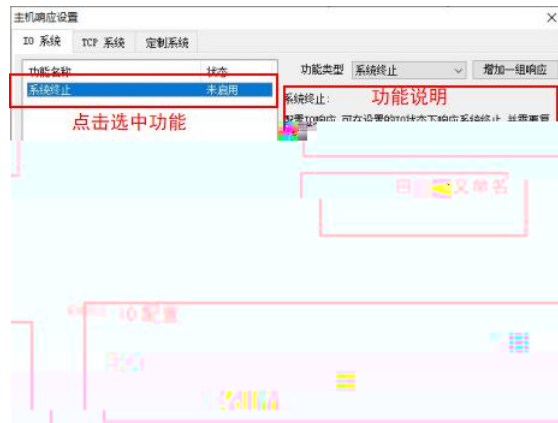
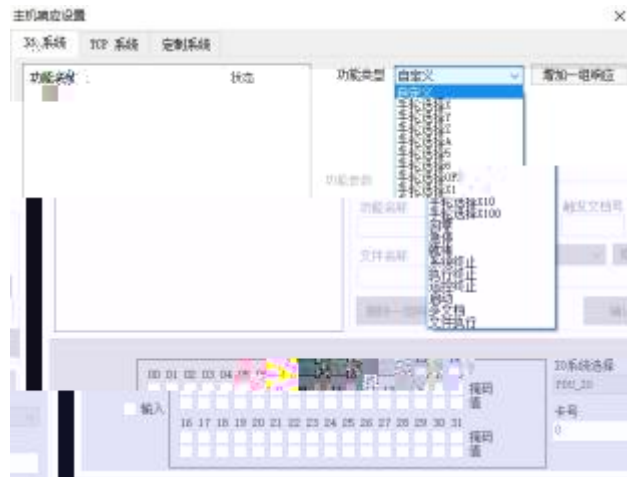

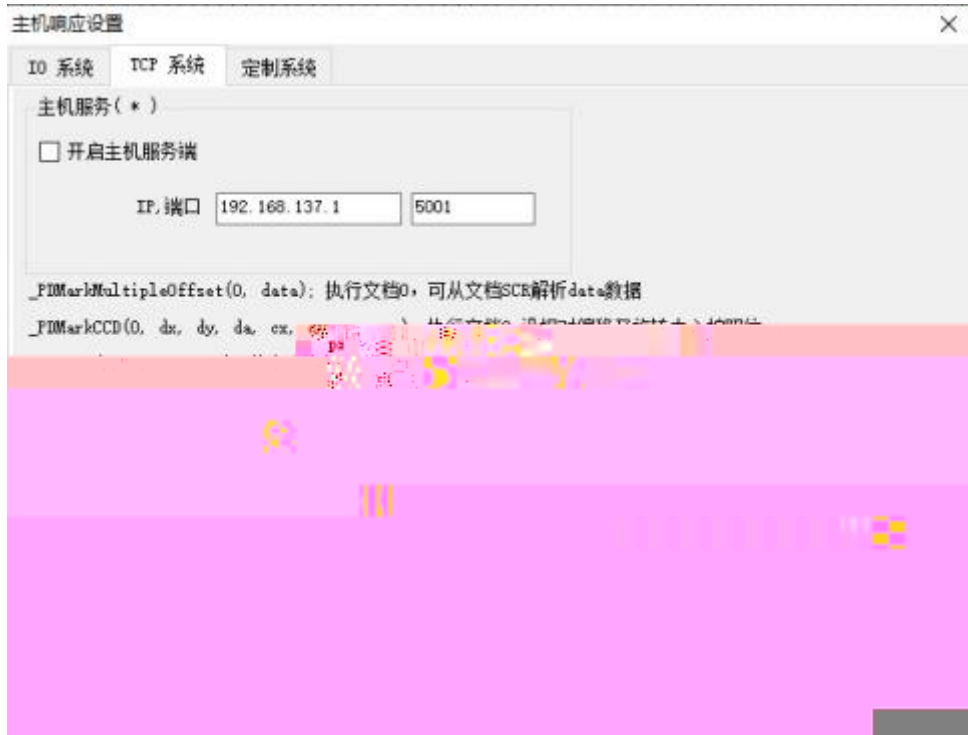

---





---

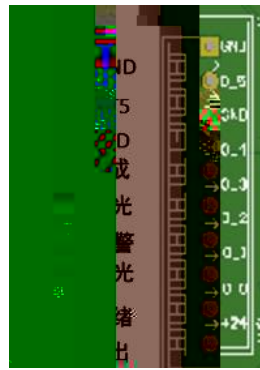

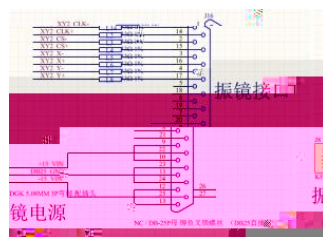
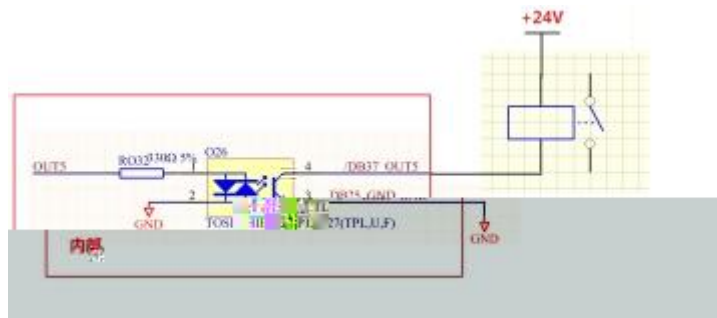





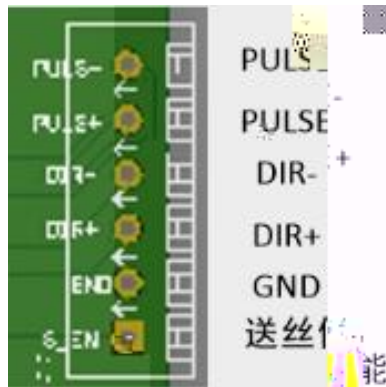
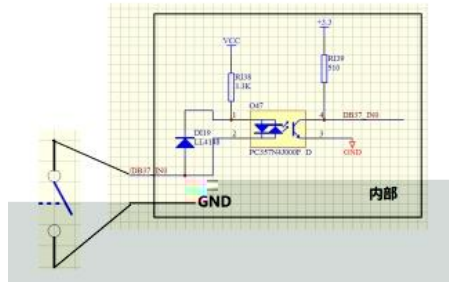

W

5

VANPAC\$H

P #8€`

#

n

L

A



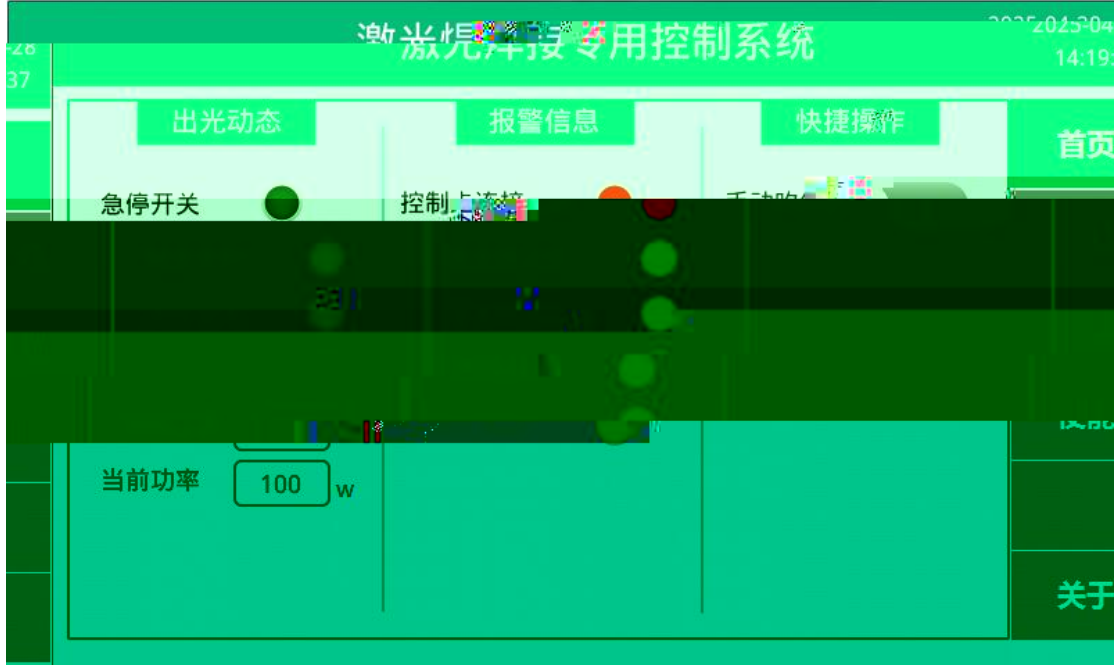

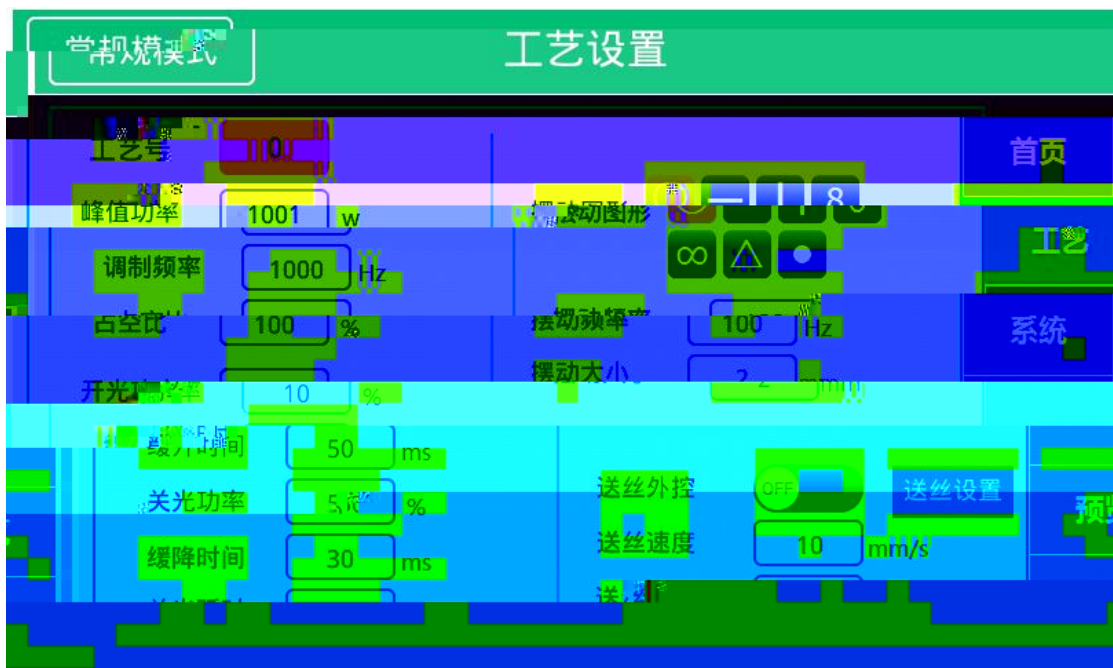
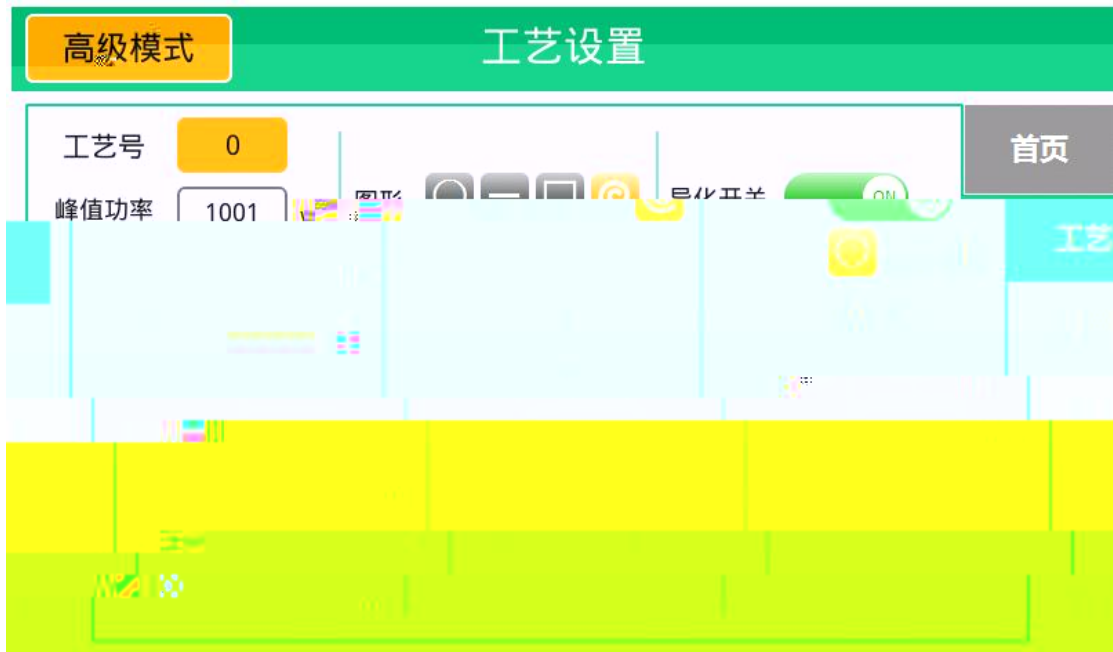

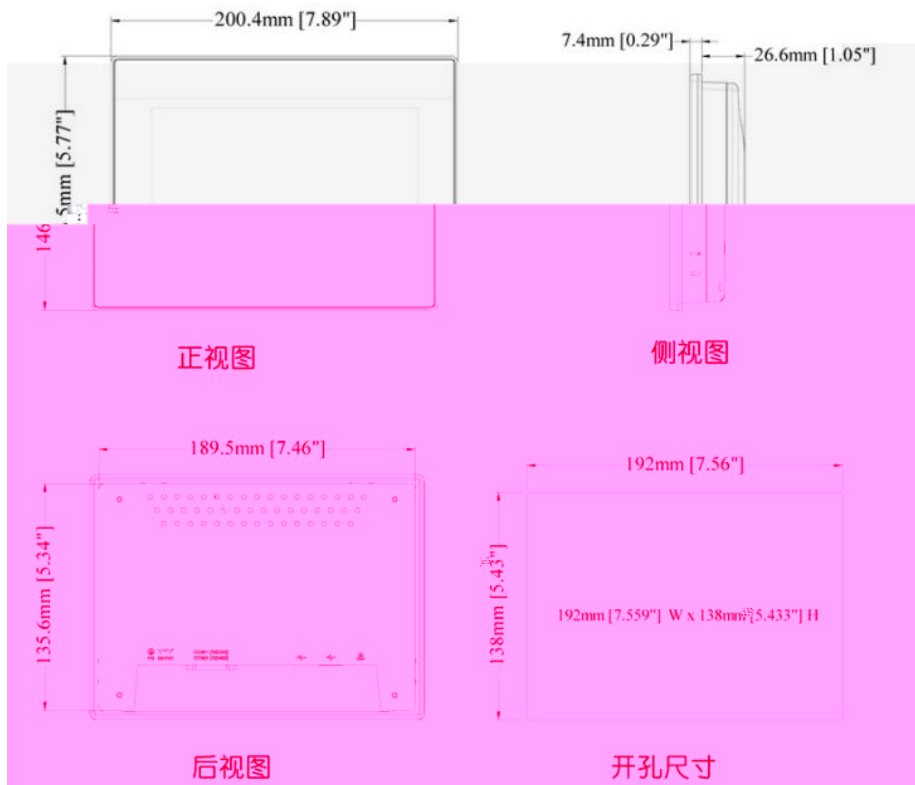

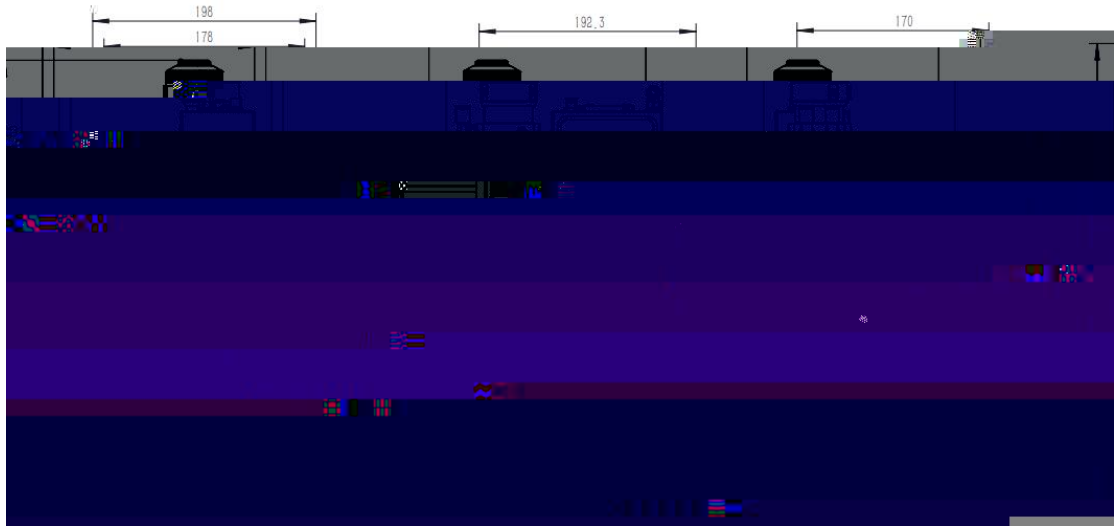



嘉强 上海 华信技术股份有限公司

地址：上海市松江区东宝路